

MENU 58

**SÁT THỦ CỦA GIỚI ĐẦU
BẾP**

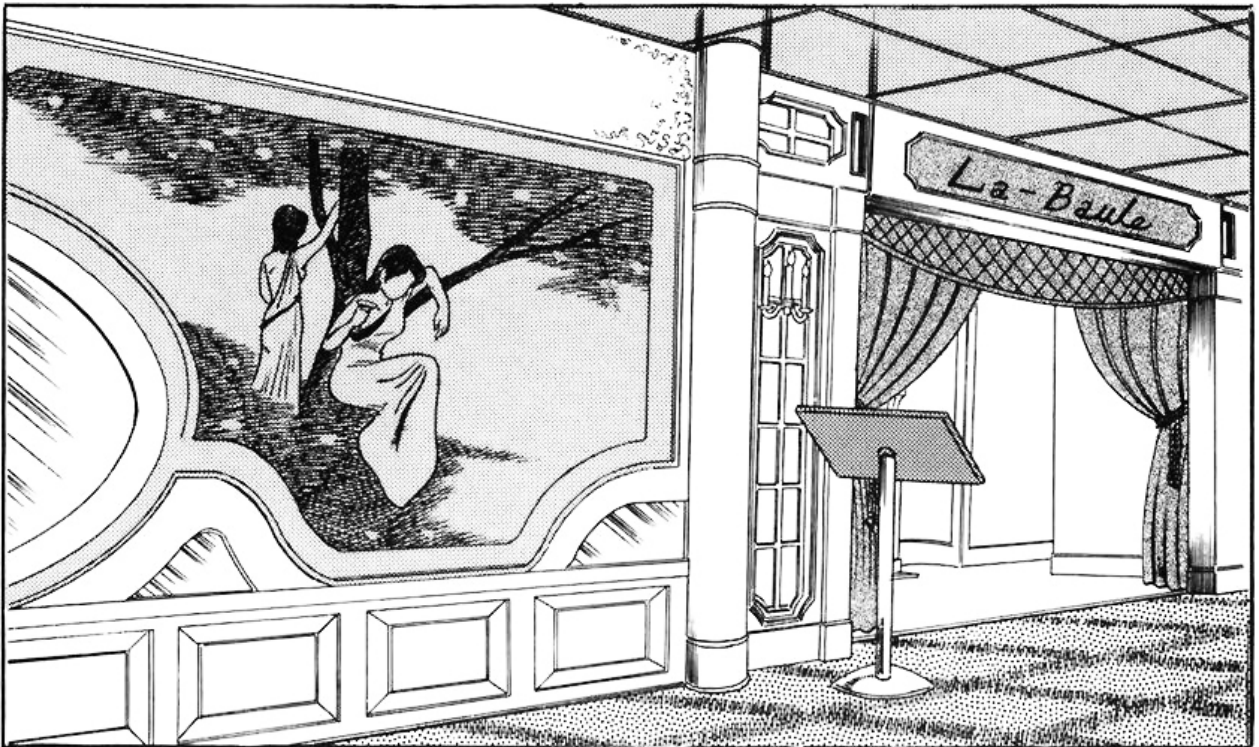

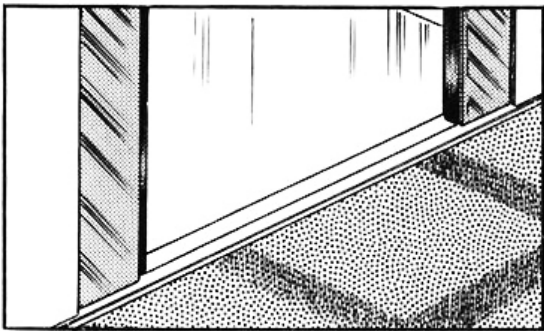
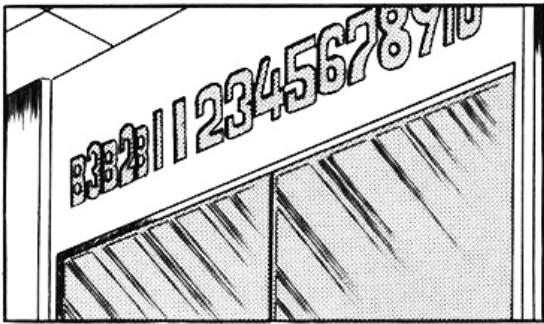

《料理人殺し》

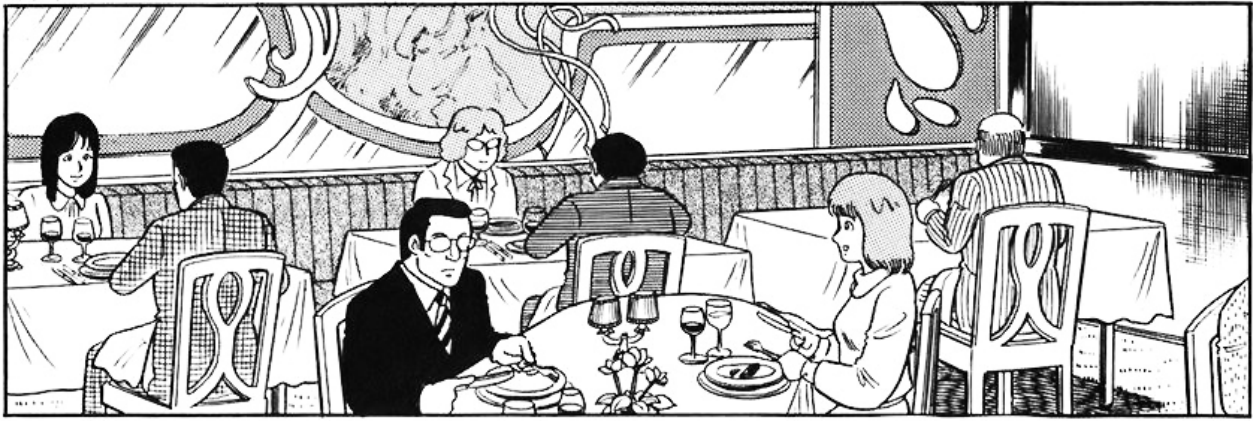

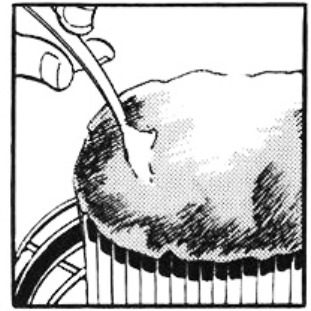

《料理人殺し》





ĐÂY...ĐÂY
LÀ MỘT ÍT



KHÔNG
KHÔNG PHẢI Ỗ
VẬY...

ANH TƯỜNG TÔI NGỐC LẠM
HẢ? CỨ TƯỜNG TÔI NUỐT
MÓN TIỀN NÀY VÀO SẼ
KHEN NGỢI NHÀ HÀNG
ANH SAO?



CHỈ VÌ NHỮNG KẼ
NHƯ ANH NÊN NHÀ
HÀNG KIỂU CHÂU
ÂU Ở NHẬT MỚI
KHÔNG TIẾN BỘ
ĐƯỢC

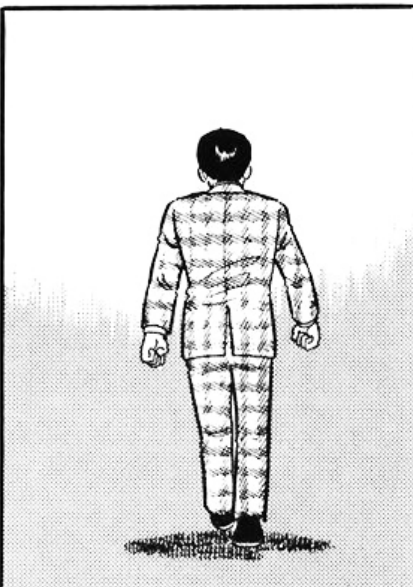

XIN ĐỢI
ĐÓN NGÀI
LẦN NỮA

VÂNG...

THÔI ĐƯỢC ĐỂ CHO CÔNG
BẰNG NƠI NÀO TÔI CŨNG GHÉ
2 LẦN CÒN VỀ VIỆC TÔI PHÊ
PHÁN THẾ NÀO SAU NÀY SẼ
BIẾT

《料理人殺し》

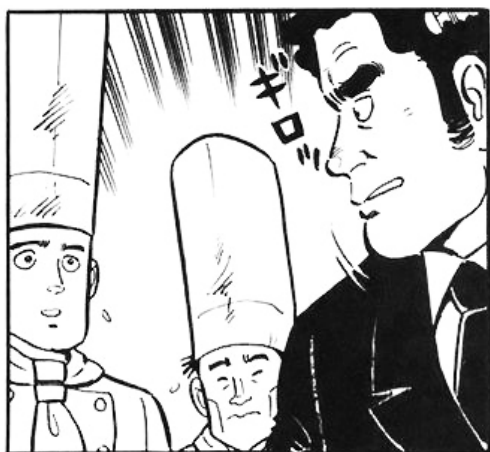

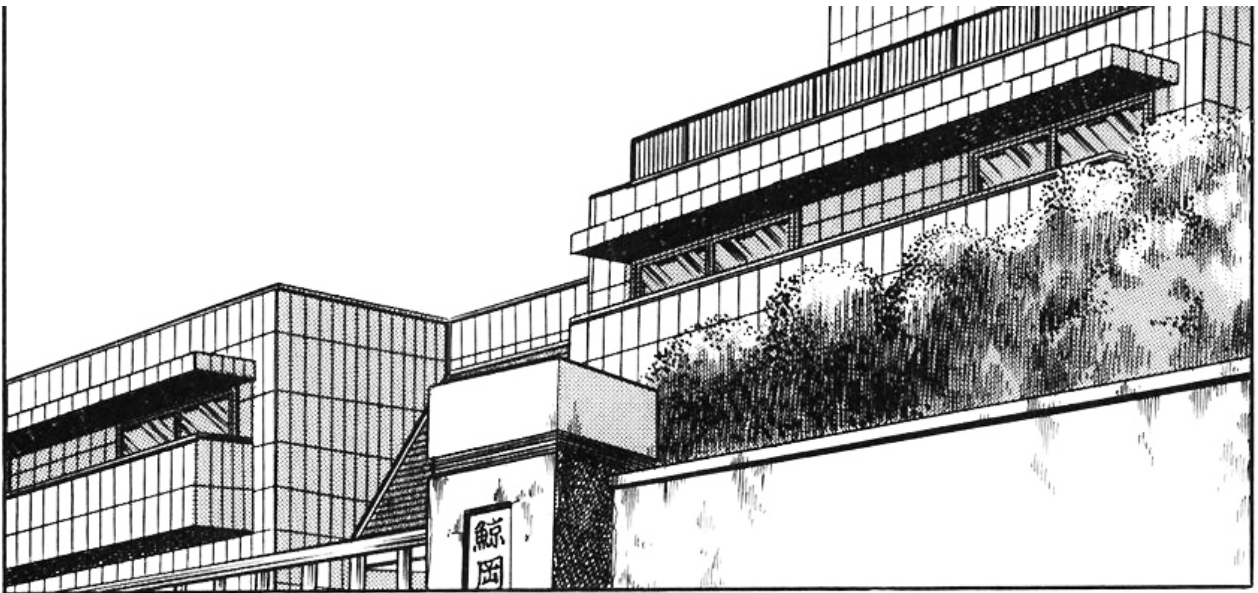

《料理人殺し》

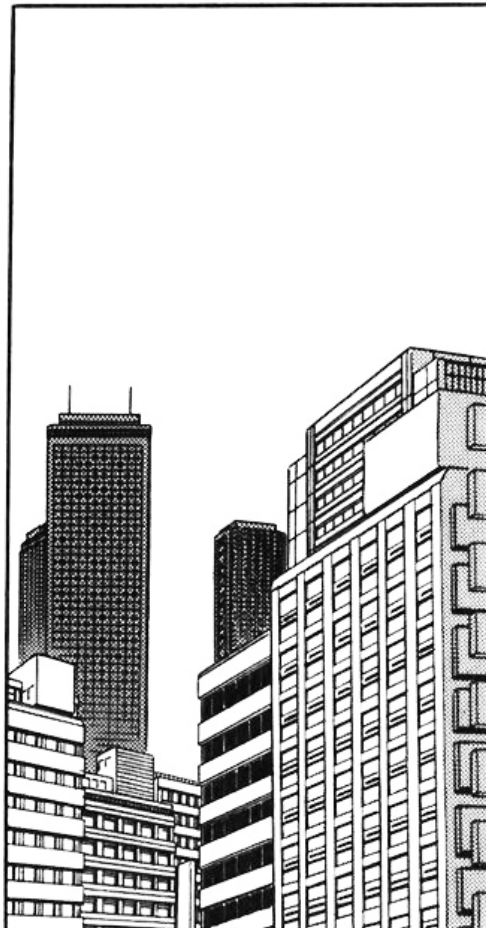
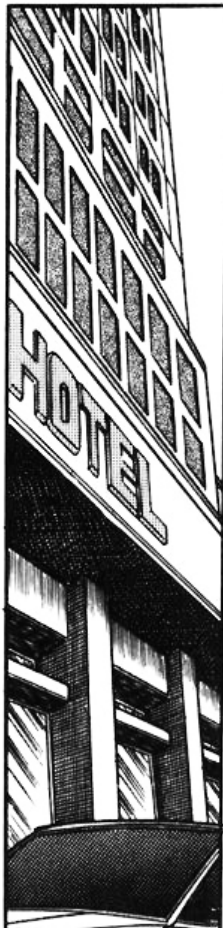



《料理人殺し》

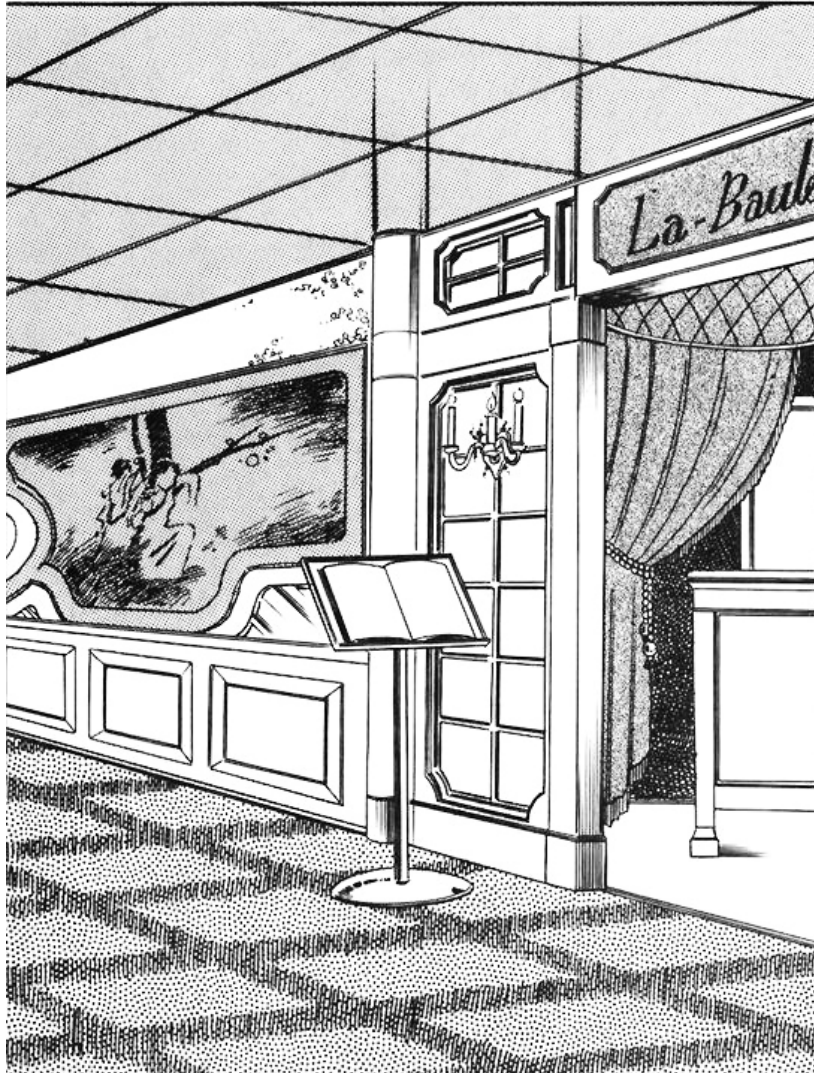

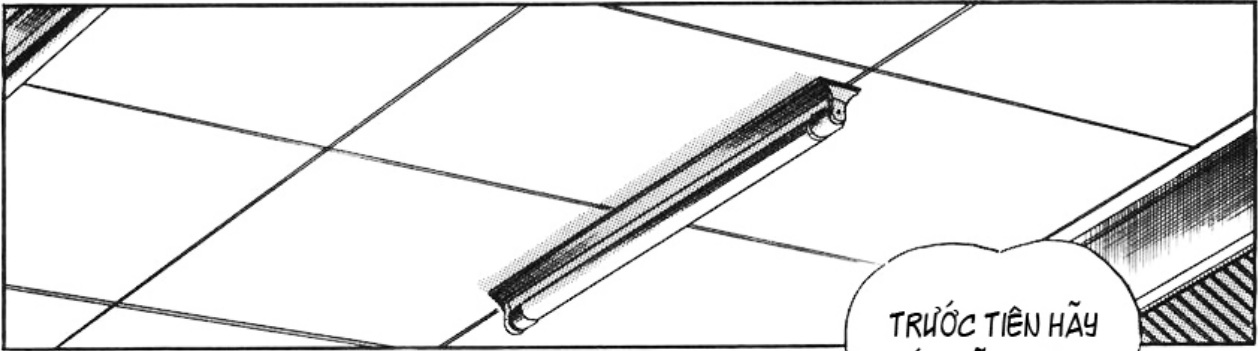

TRƯỚC TIÊN HÃY
SẮP SẴN NHỮNG
THỨ TÔI CẦN RA



VÂNG



THỊT GÀ, TRỨNG,
HÀNH, VỊT RONG
BIỂN VÀ GẠO
TRẮNG

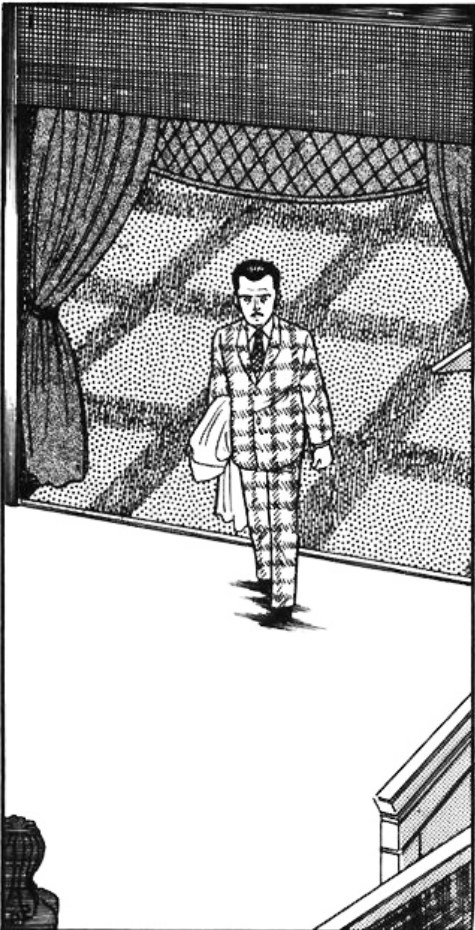

THẬT
TÌNH...
SAO? HÃN ĐỊNH
NẤU MÓN GÌ
VẬY?

《料理人殺し》

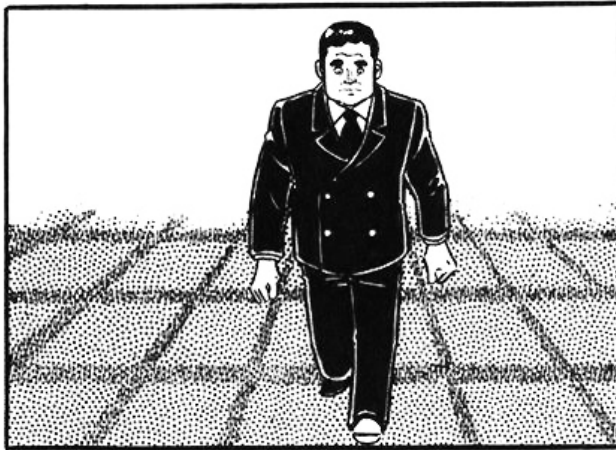

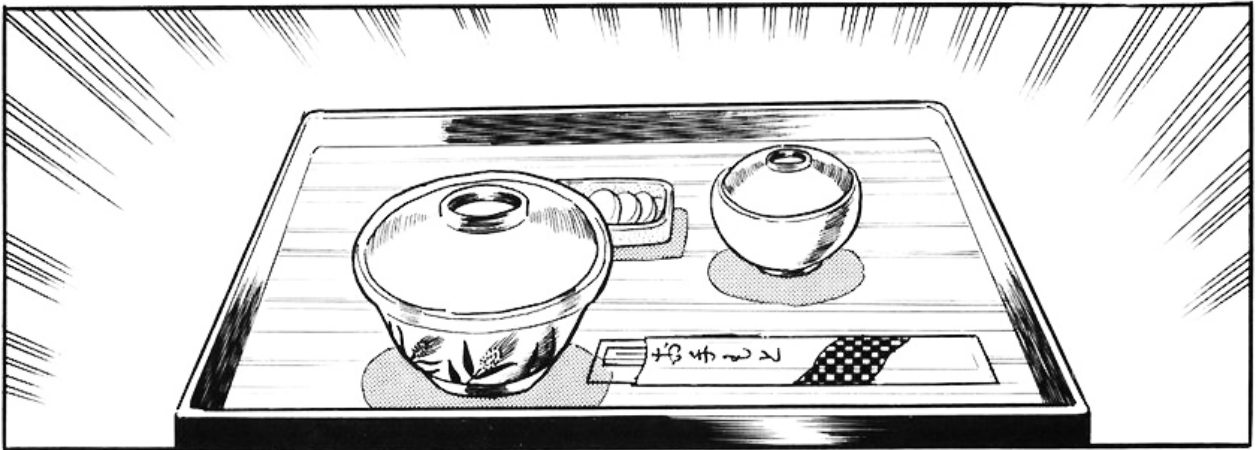
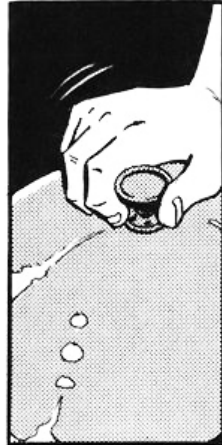
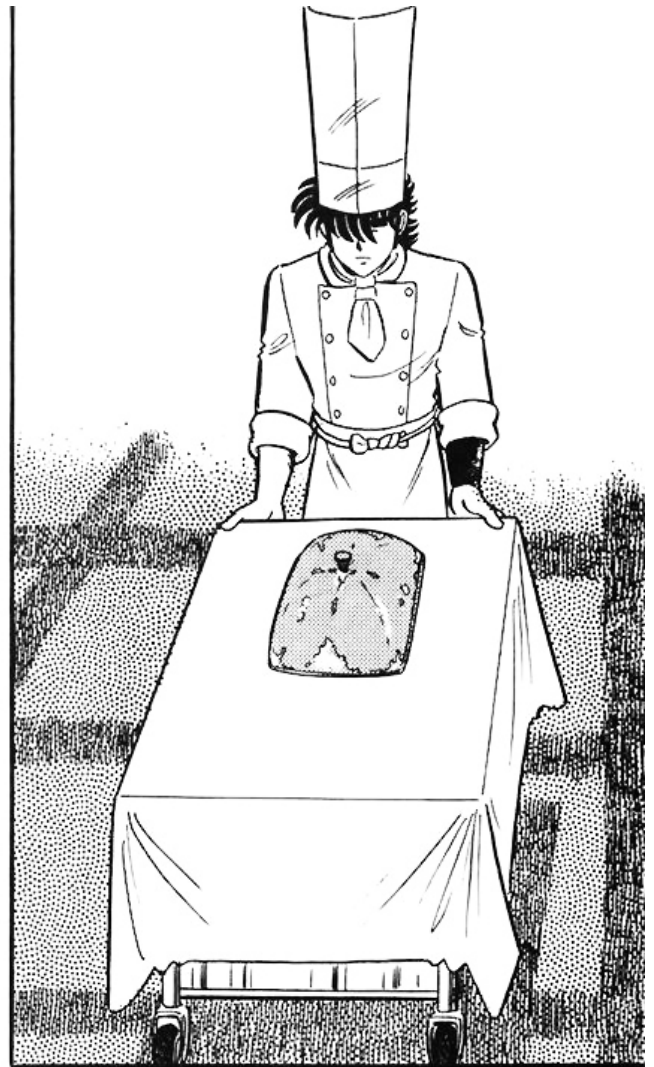

《料理人殺し》

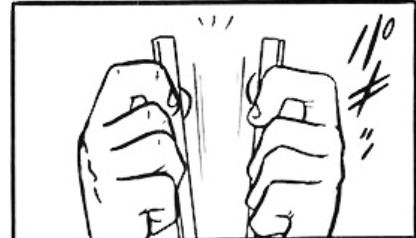

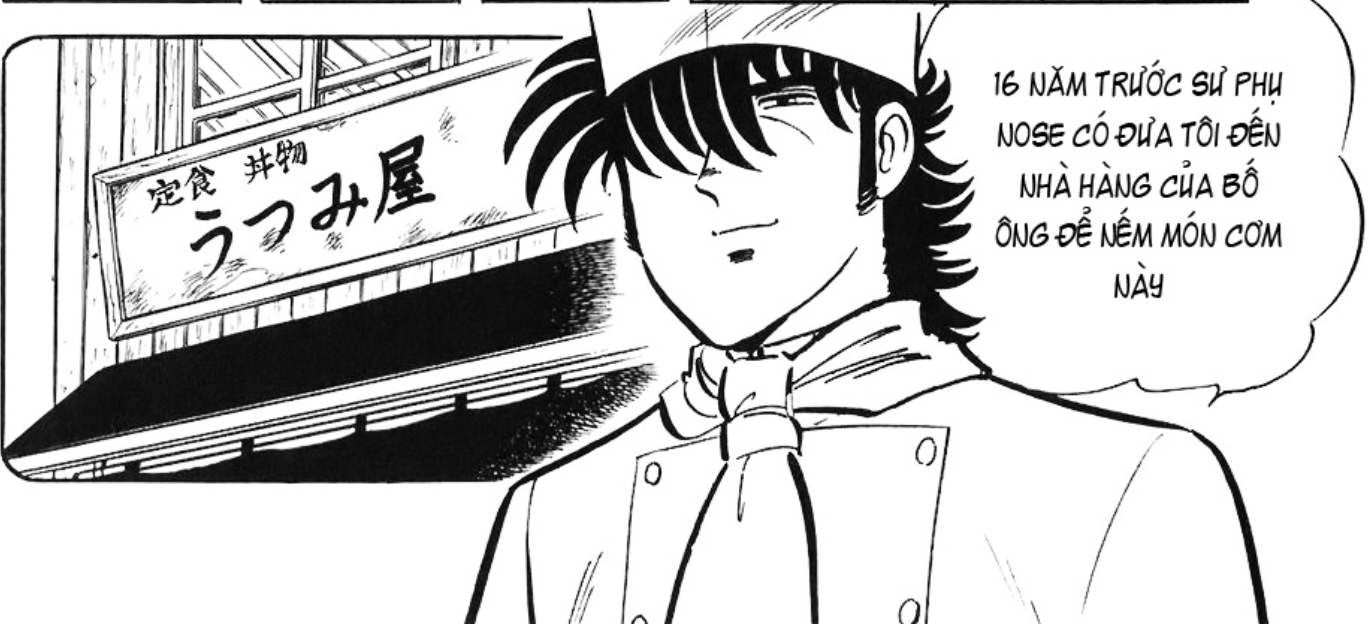

《料理人殺し》

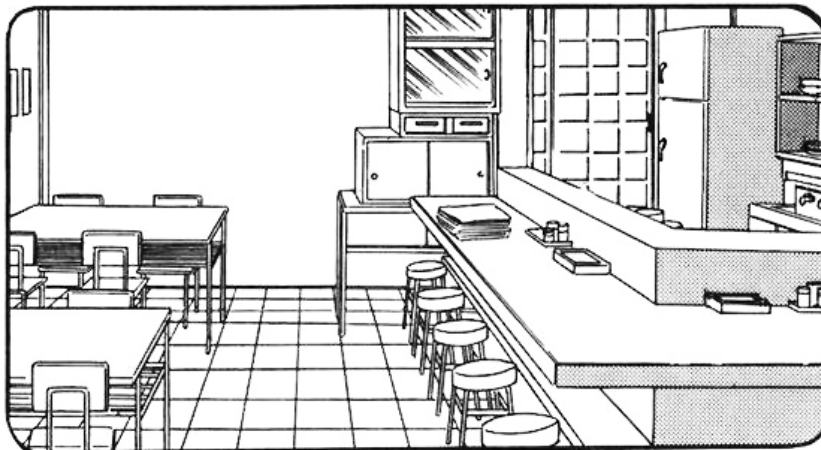

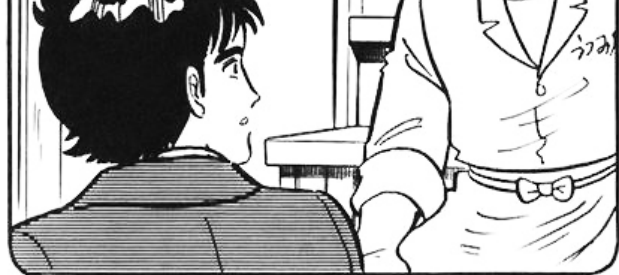
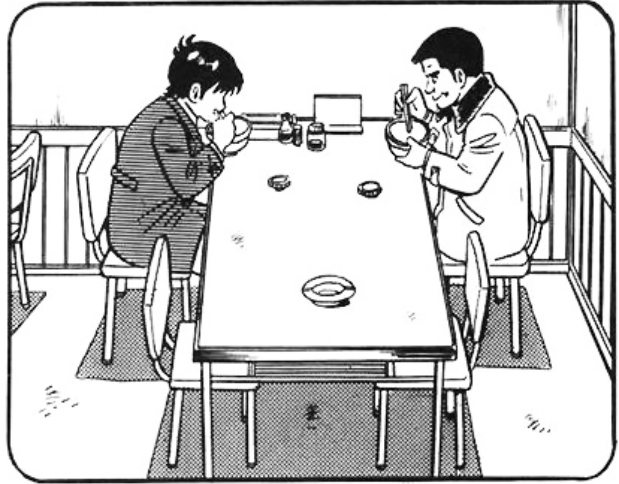

《料理人殺し》

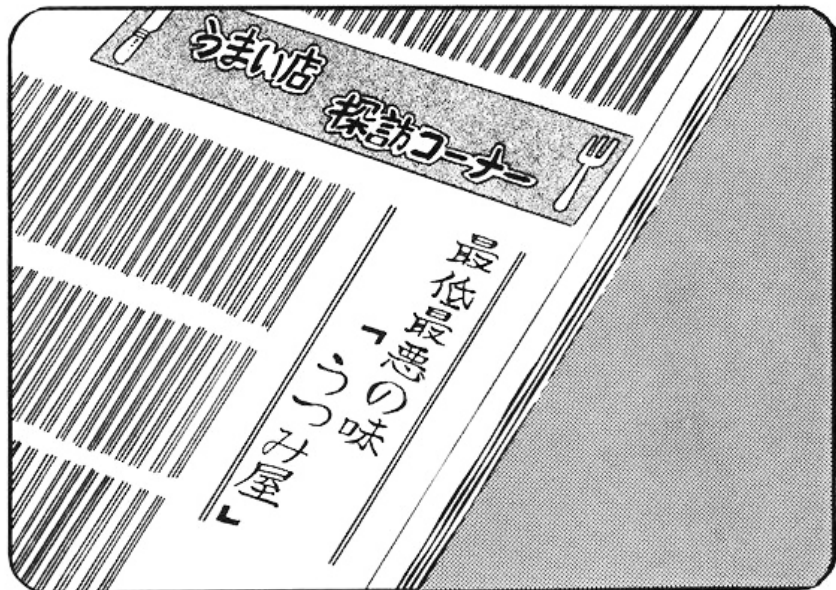
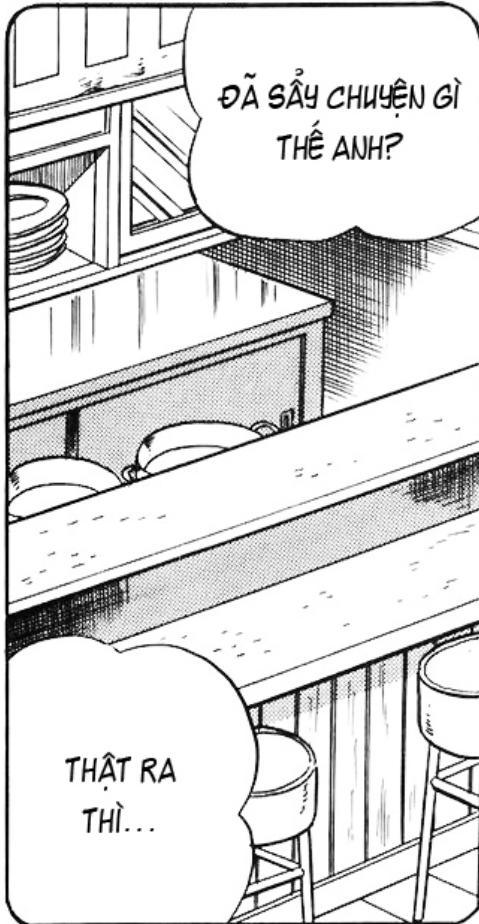

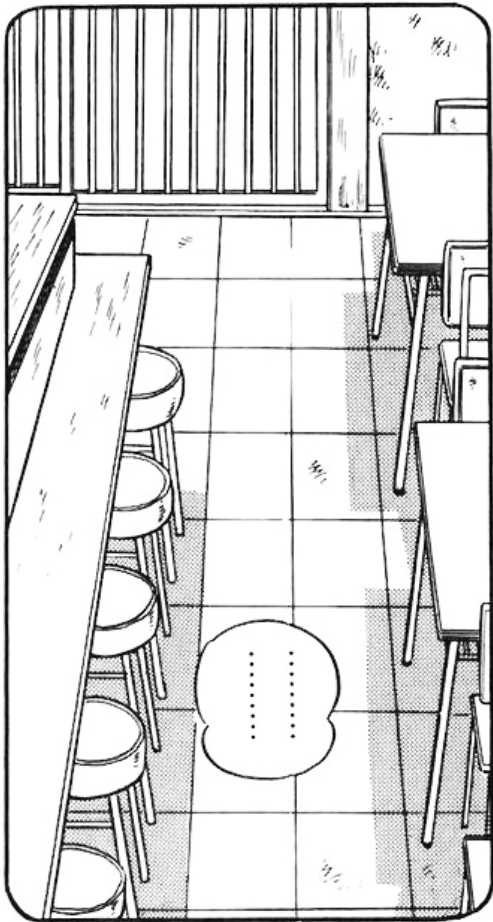

《料理人殺し》



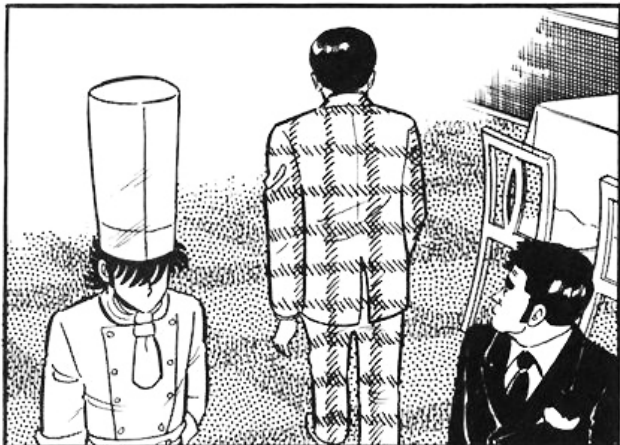

《料理人殺し》

