

81 :

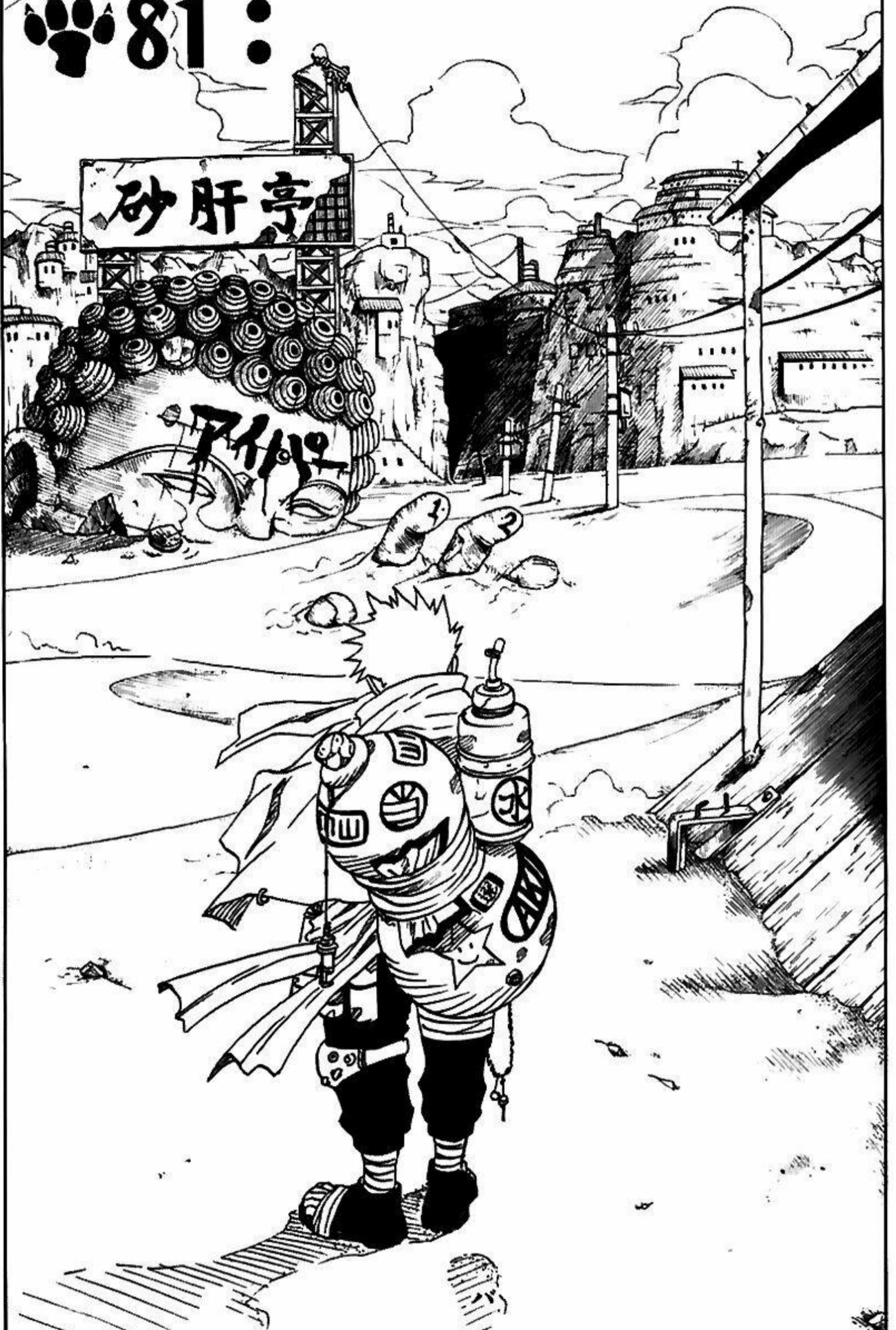

GAARA VS ...

BLOGTRUYEN.COM



KẸ THẤT BẠI
MÃI MÃI CŨNG
CHỈ LÀ KẸ THẤT
BẠI ...

KHÔNG CÓ
CHUYỆN THAY
ĐỔI ĐƯỢC !



HỪ
...



MUỐN
KIỂM
CHỨNG
KHÔNG
...

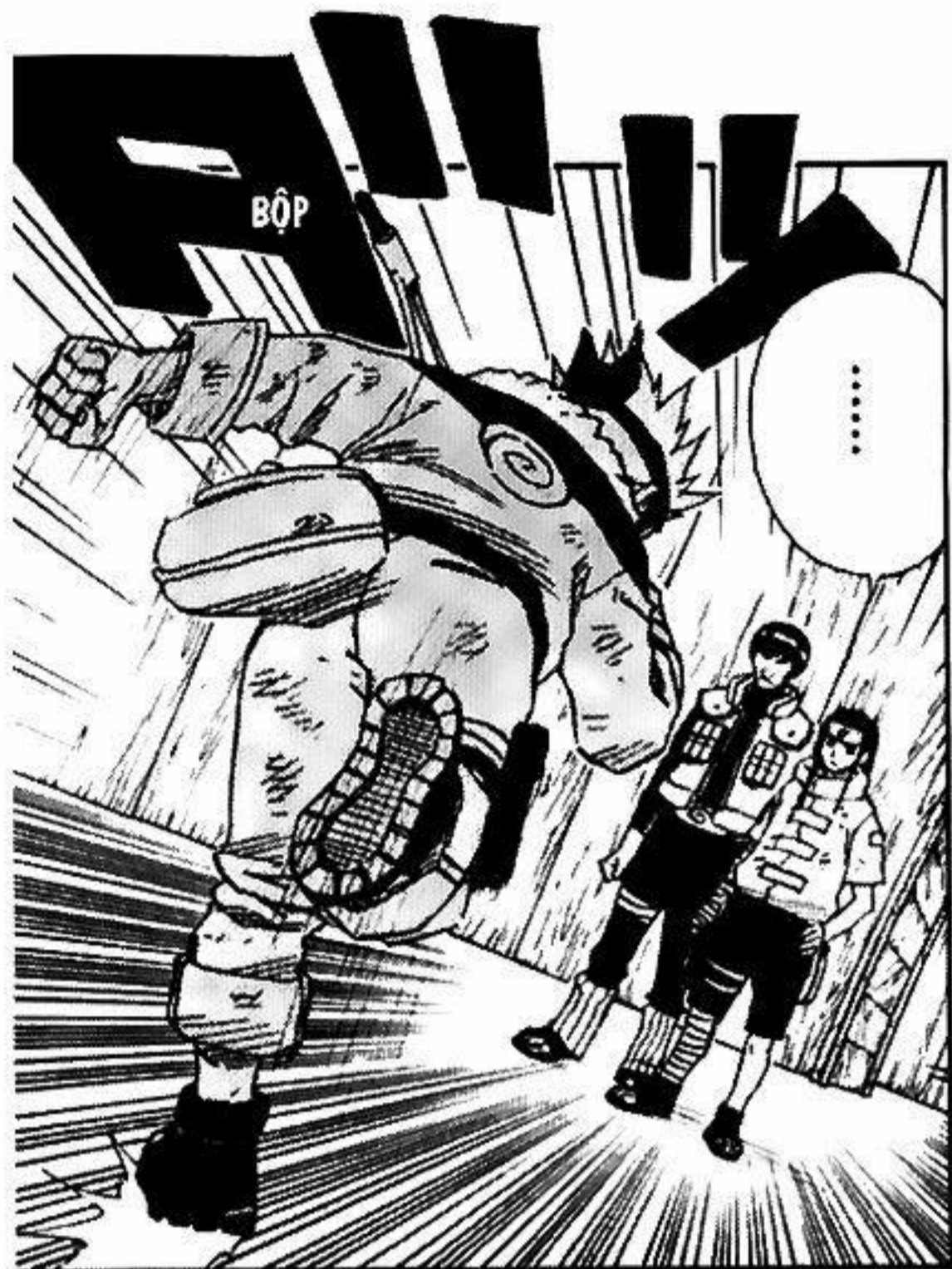



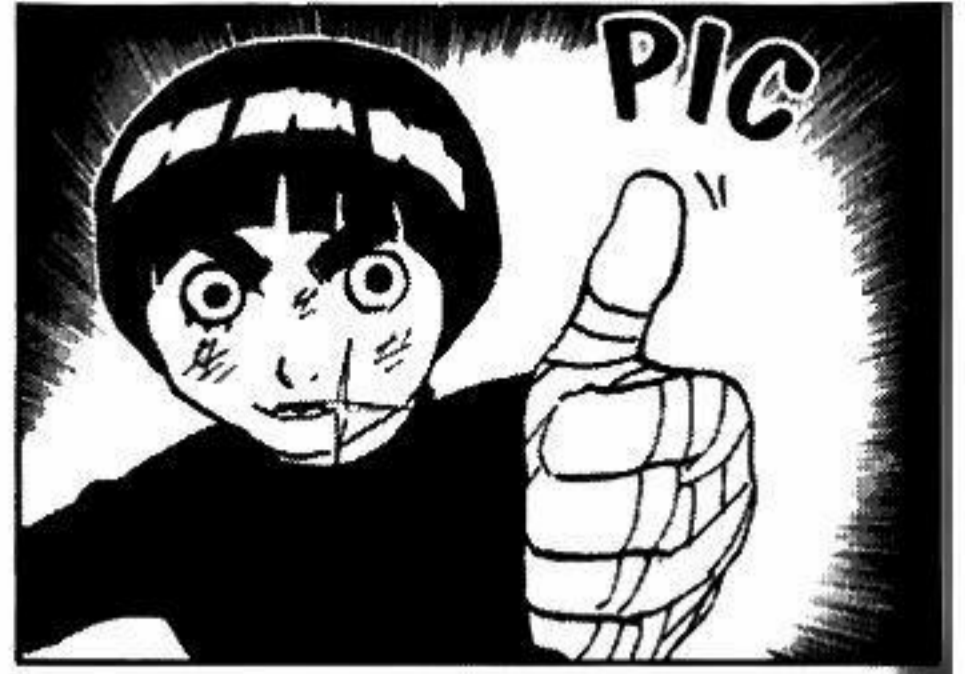



X ...
XIN LỖI

HẾT

ĐỘI Y TẾ ĐỨNG
ĐÓ LÀM GÌ!
MAU LÊN!

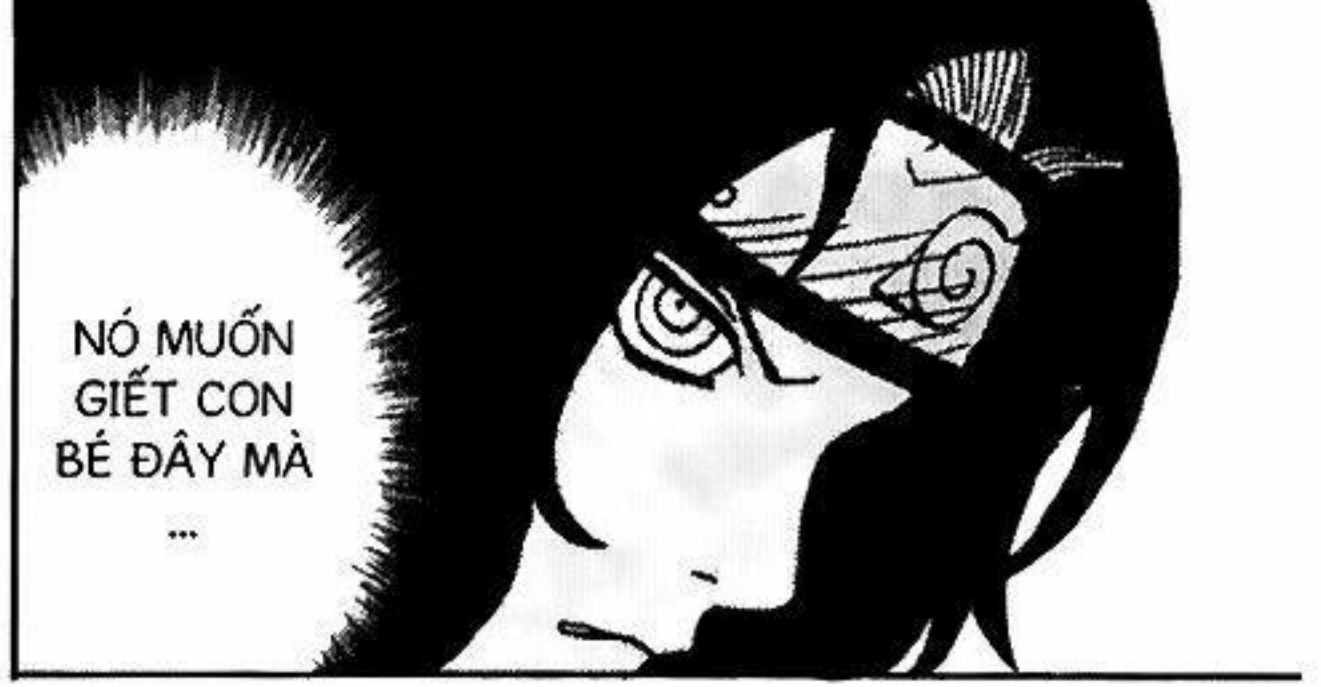

NÓ MUỐN
GIẾT CON
BÉ ĐÂY MÀ
...



THÌ NÊN
KHÁM CHO
CON BÉ
ĐÓ ĐI THÌ
HƠN

CÓ THỜI
GIAN ĐỂ
LƯỜM TÔI
NHƯ THẾ
...



BỘP

TÌNH HÌNH
NÀY CON BÉ
KHÔNG CHỊU
NỔI 10 PHÚT
NỮA ĐẤU!

MAU ĐEM
NÓ ĐẾN
PHÒNG CẤP
CỨU ...
**MAU
LÊN!**



TRÁNH
ĐƯỜNG
!

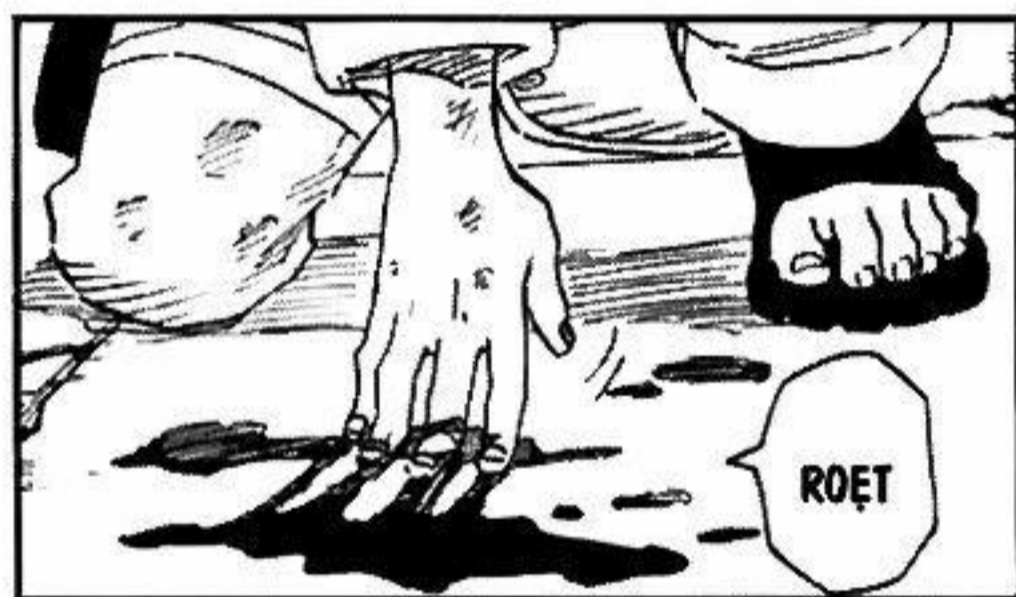
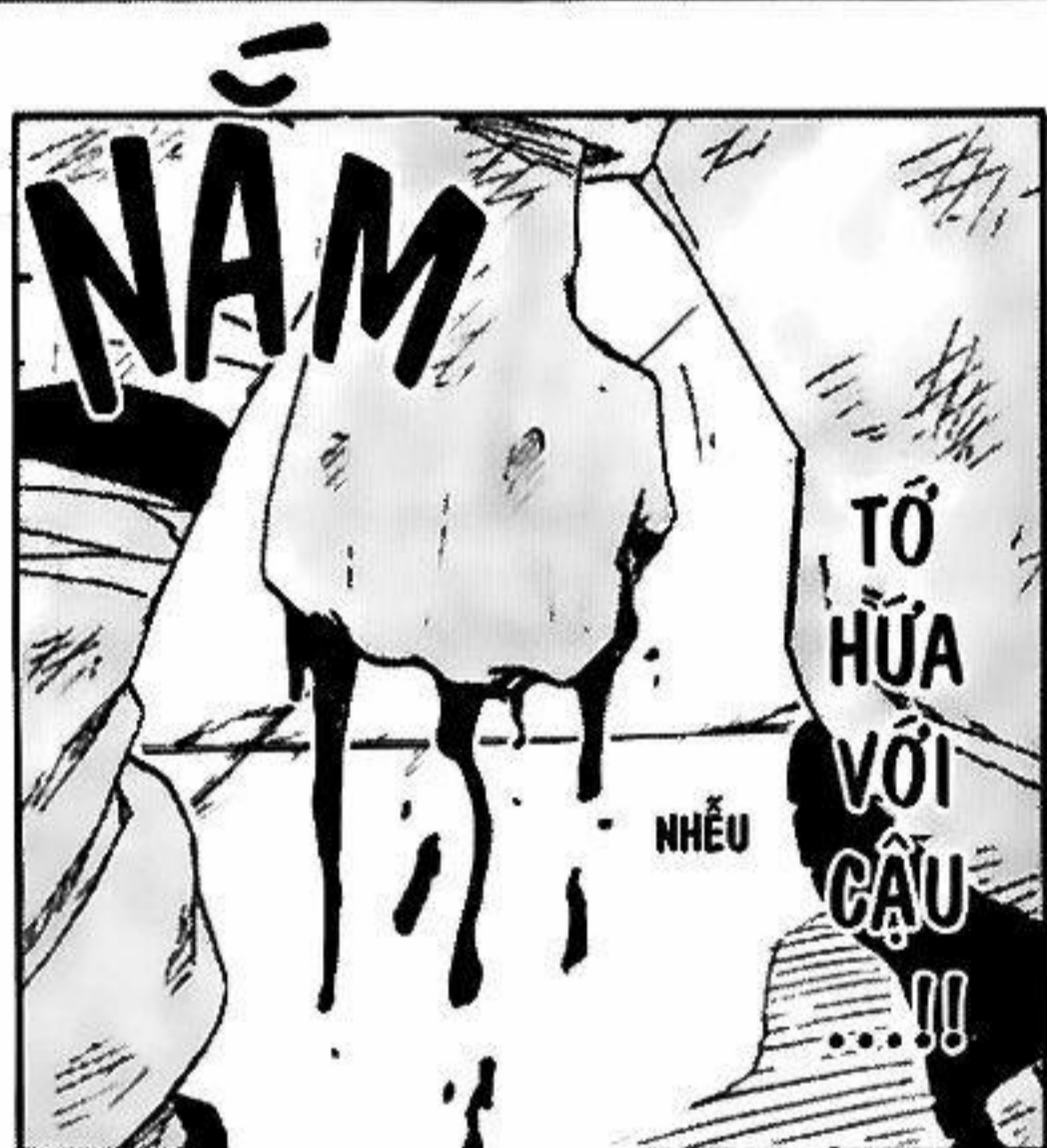

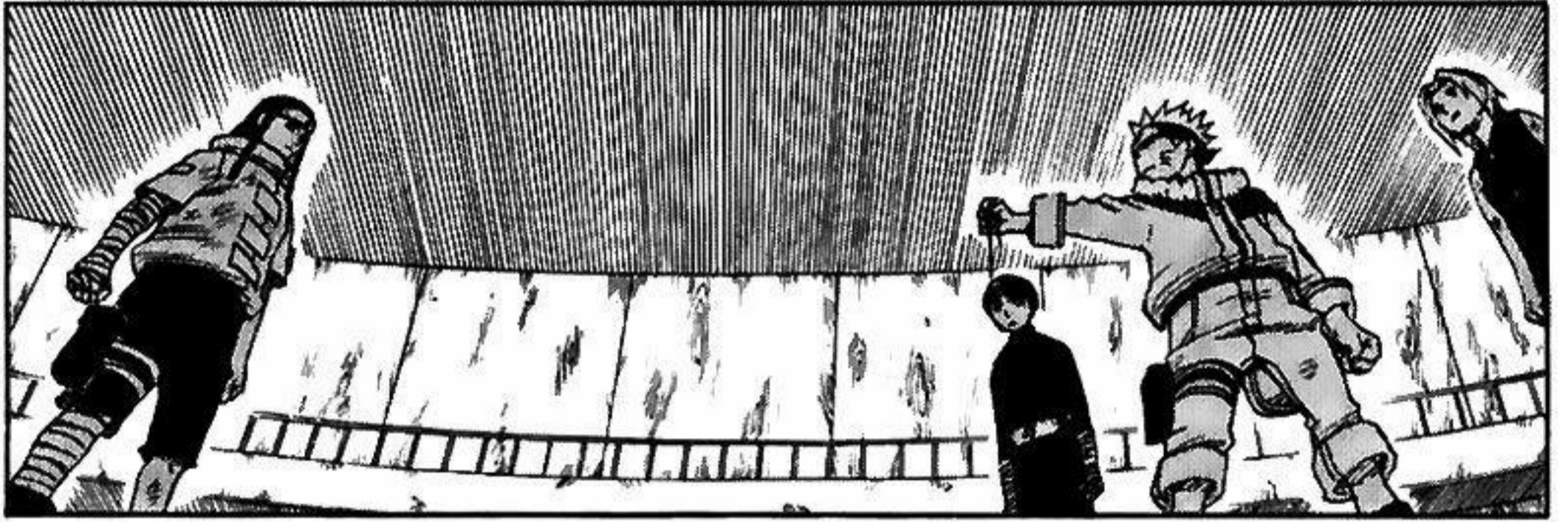

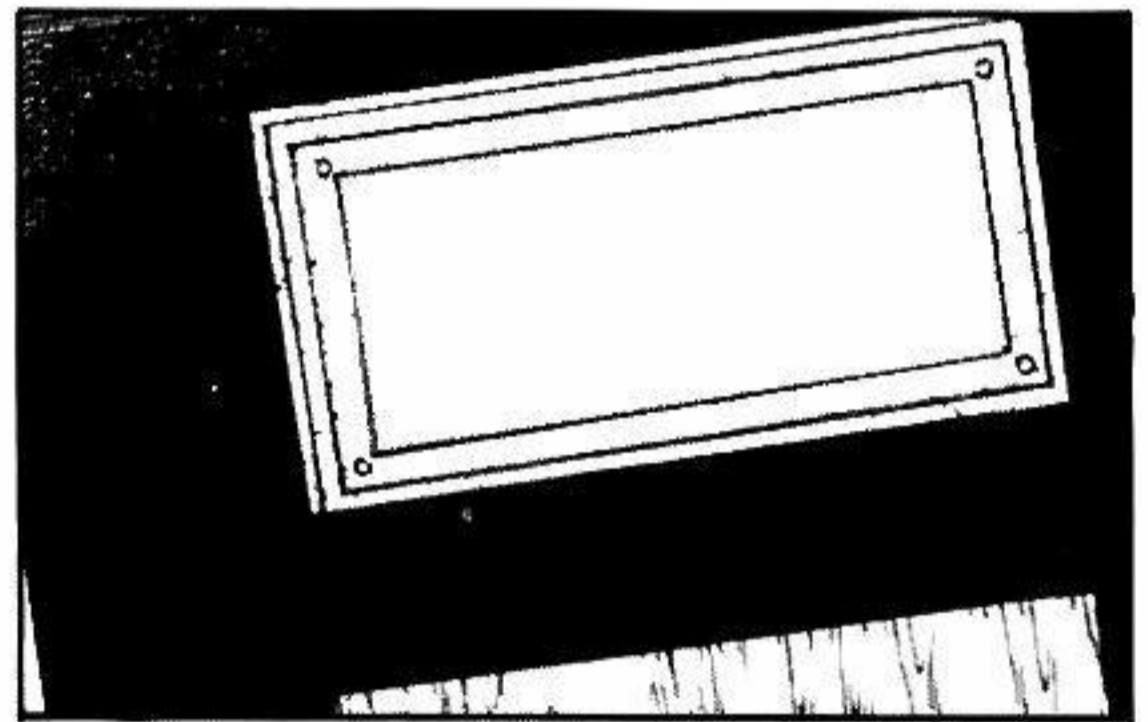



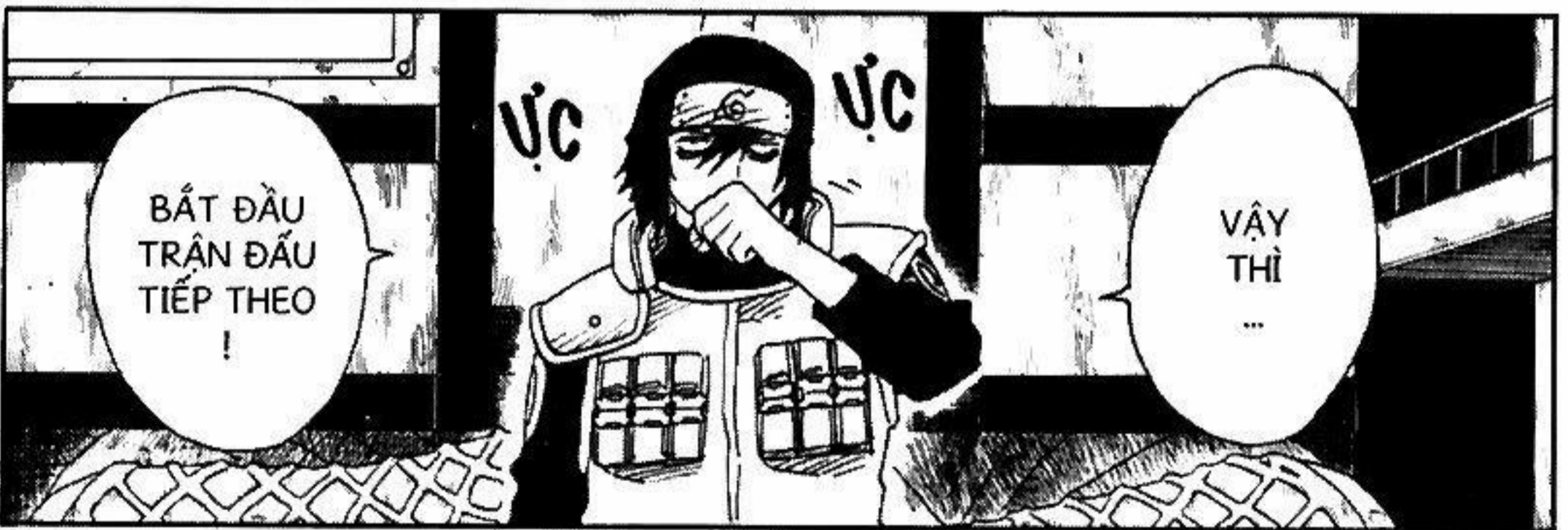
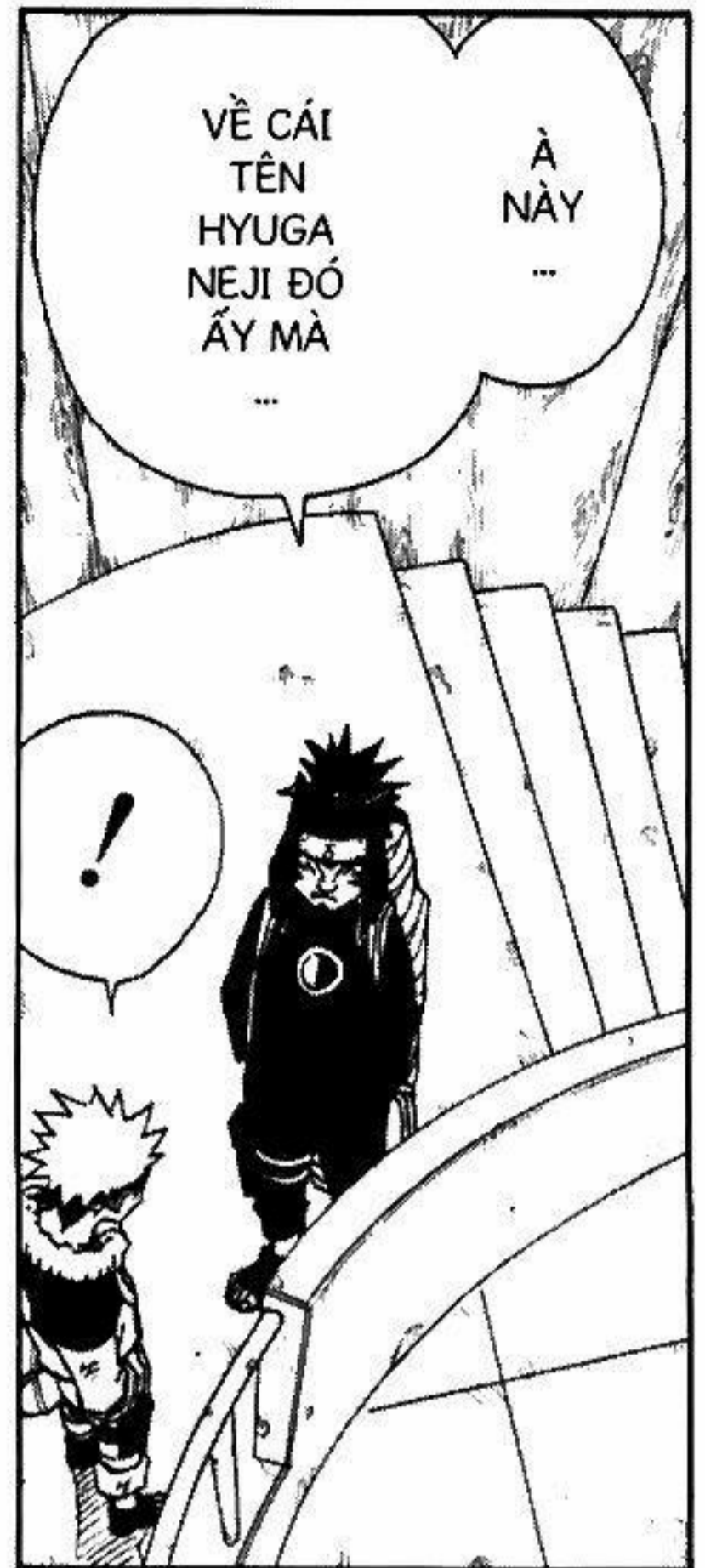



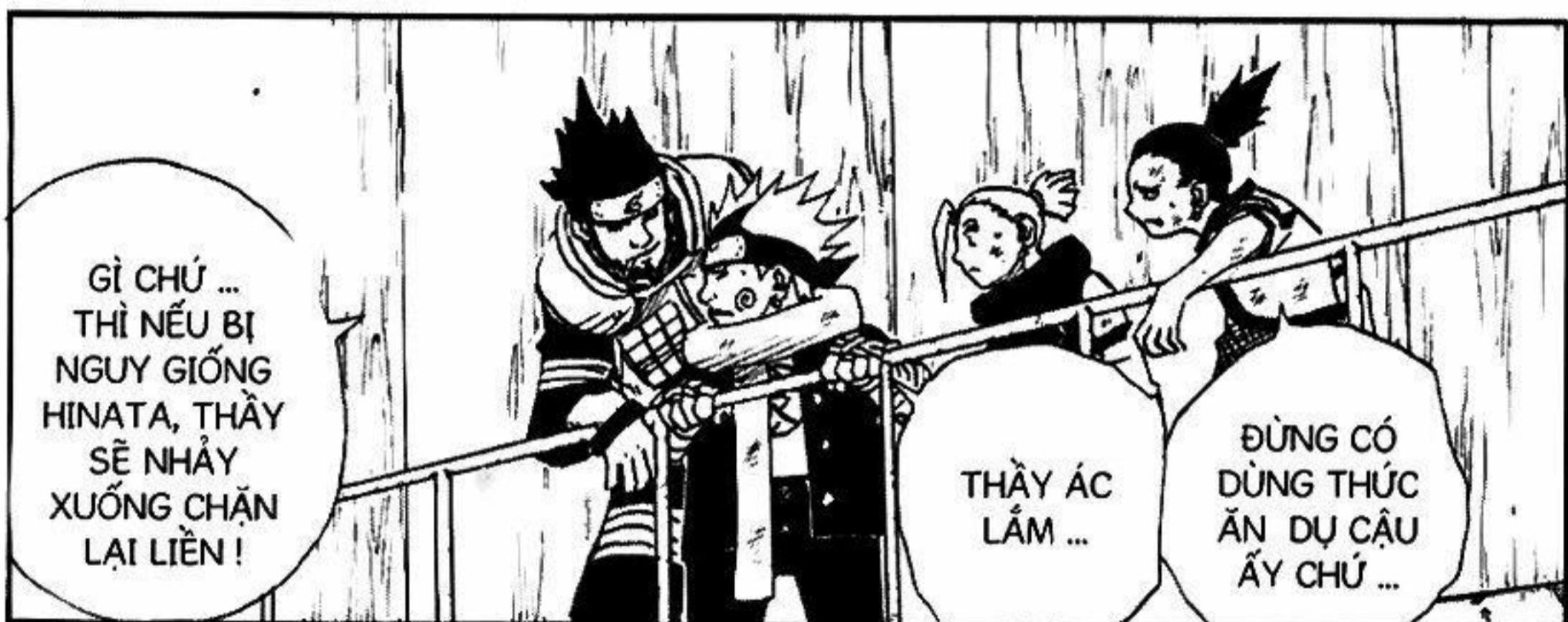

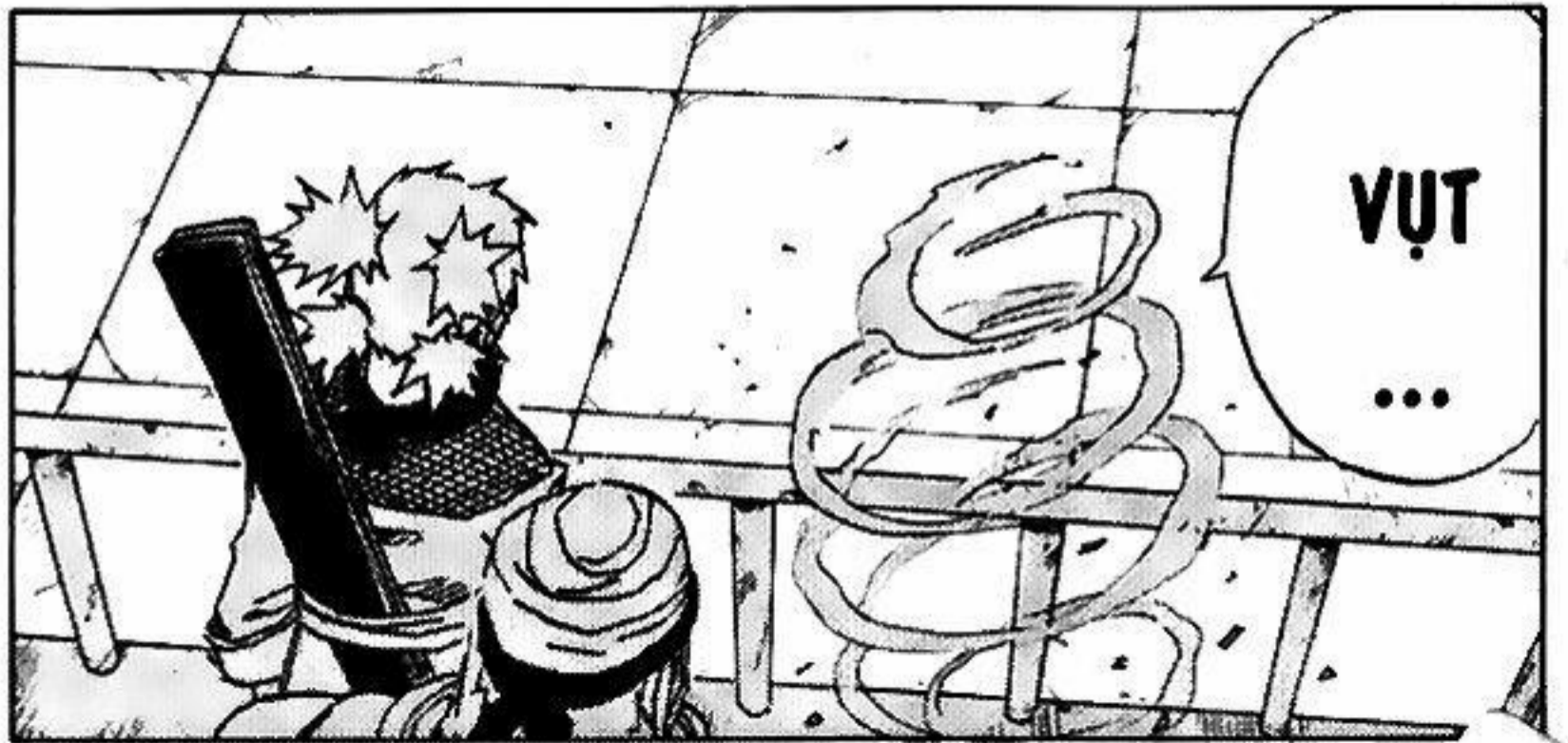
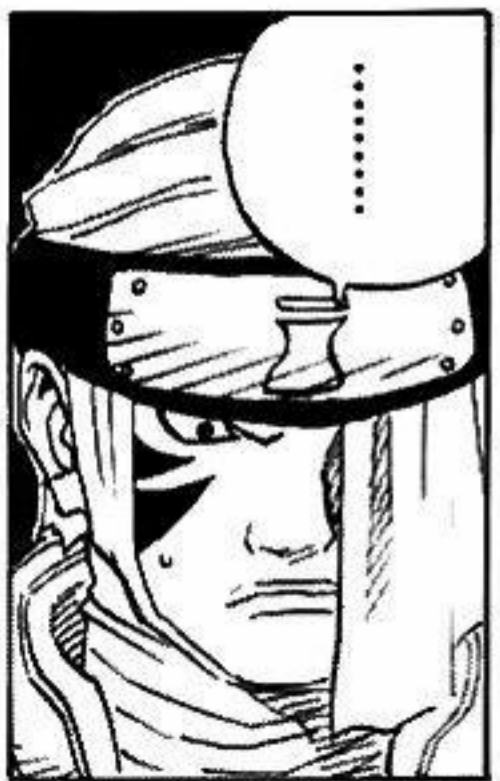
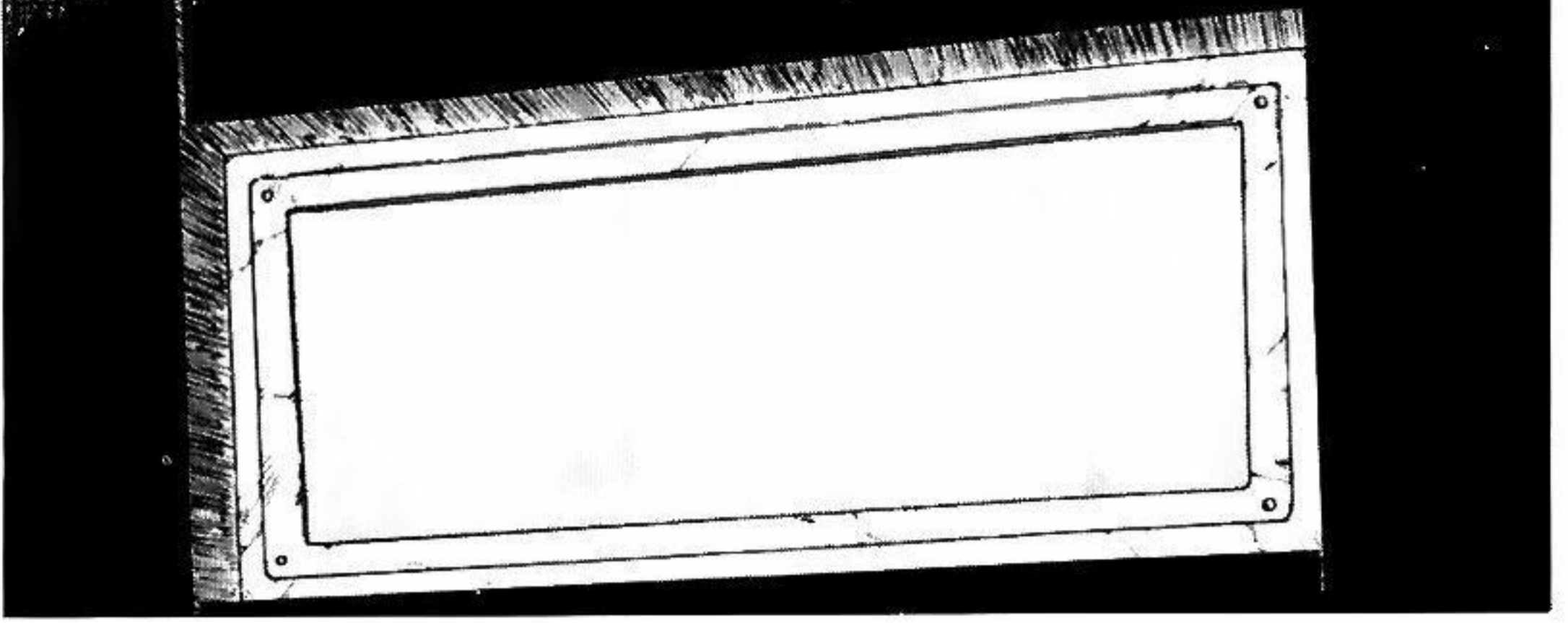



XOAC

XUỐNG
MAU ĐI

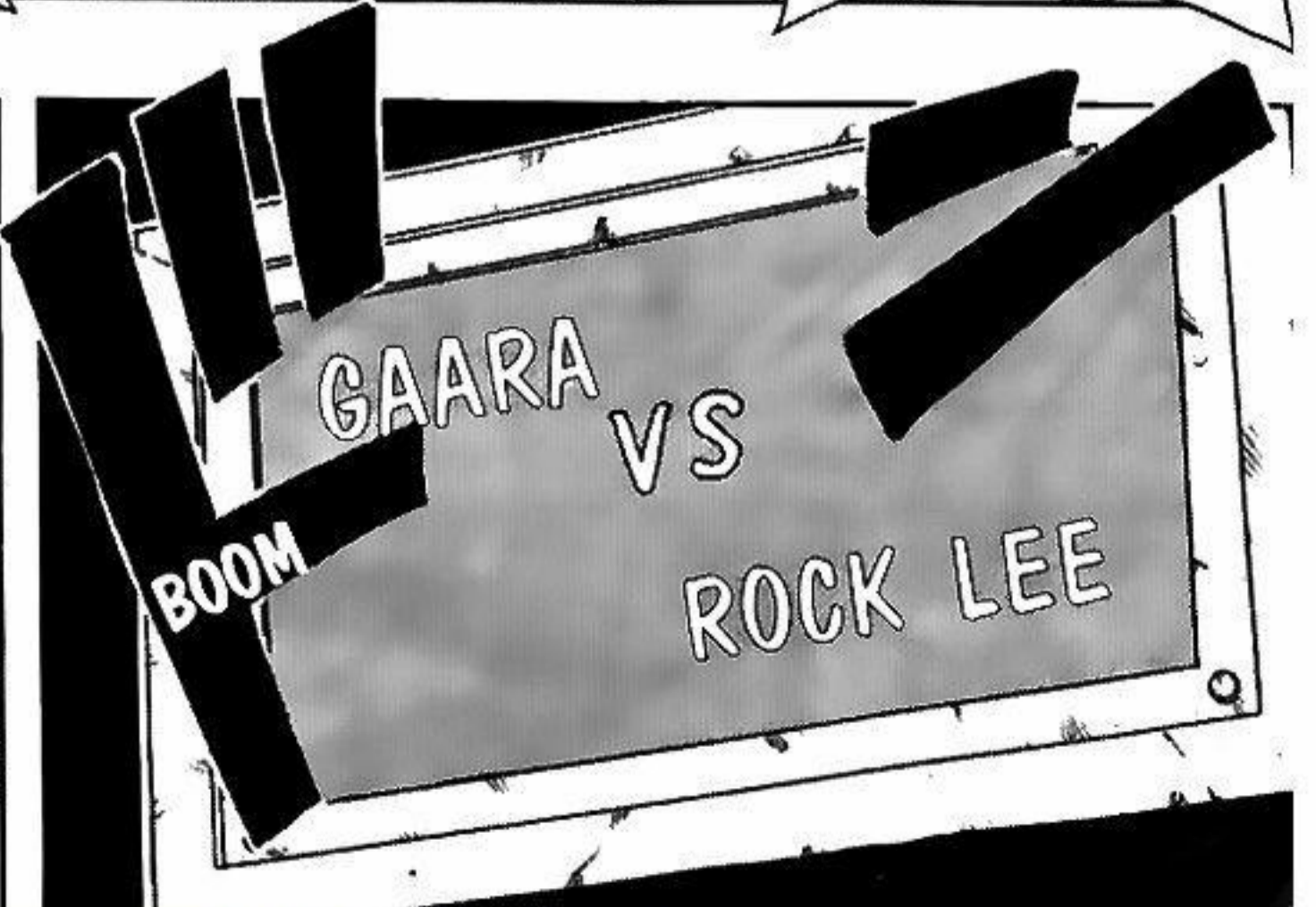
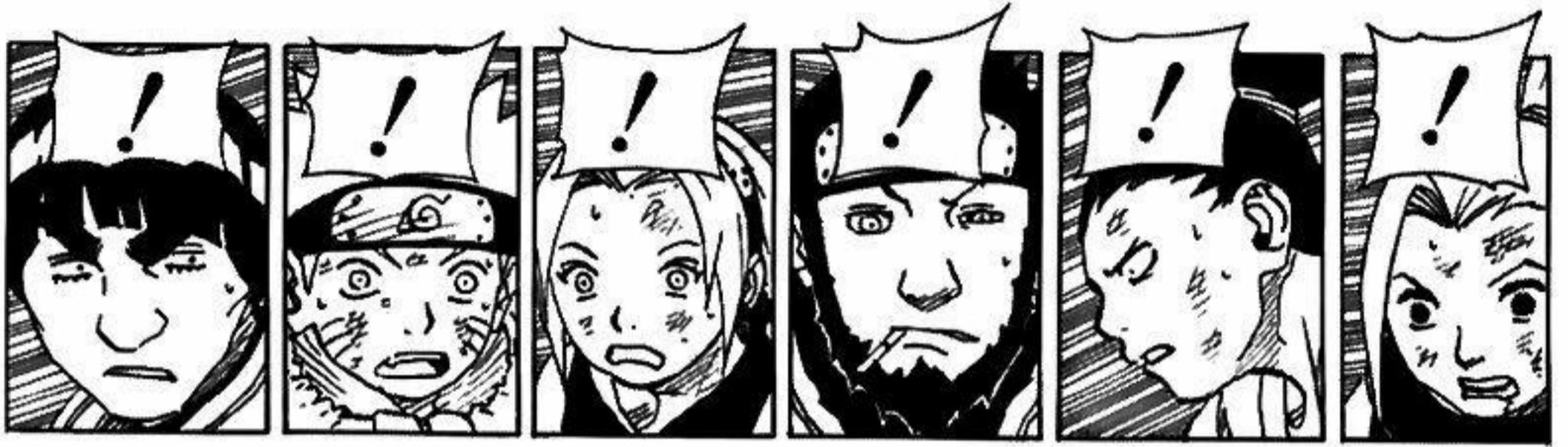
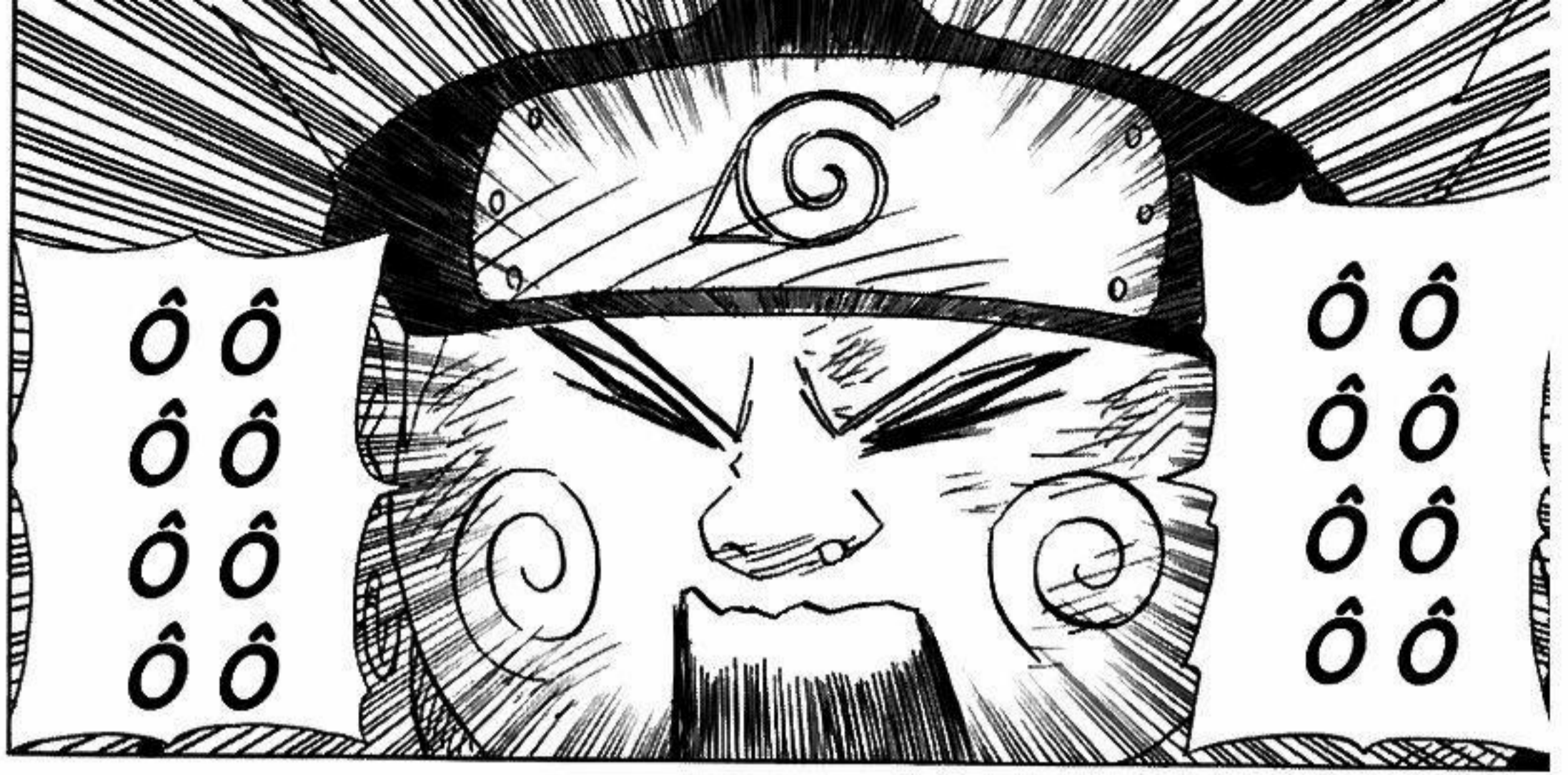



VẬY SAO BẢO LÀ TRƯỢT ĐƯỢC ...?

MÌNH KHÔNG PHẢI NHÂN VẬT CHÍNH RỒI, CẢM ƠN!



TRƯỢT MẮT RỒI!

NÓI LÀ ĐẤU CỐI CÙNG SẼ TỐT HƠN NHUNG LẠI KHÔNG ĐƯỢC NHƯ Ý!

NHUNG KHÔNG ĐỊNH NÉM TRÚNG THÌ LẠI TRÚNG!

ĐÚNG LÀ QUI LUẬT MUỐN NÉM ĐÁ TRÚNG CỘT ĐIỆN THÌ LẠI KHÔNG TRÚNG ...



VĂNG A!

GẬT

LEE, THẦY SẼ CHO EM MỘT LỜI KHUYÊN QUAN TRỌNG MÀ MỌI NGƯỜI KHÔNG ĐỂ Ý TỚI!



RA LÀ VẬY ...

HÃY GHI CHÚ LẠI! TRONG LÚC CHIẾN ĐẤU, KHÔNG ĐƯỢC PHÍ THỜI GIAN CHÚ Ý TỚI NÓ ĐẤY!

RA LÀ VẬY ...

CHẮC LEE KHÔNG SAO ĐẤU NHỈ ...



CÁI HỒ LÔ ĐÓ TRÔNG CÓ VẼ BẤT THƯỜNG ...



VĂNG A!

*BẮC

ĐƯỢC! TIẾN LÊN ĐI LEE !!

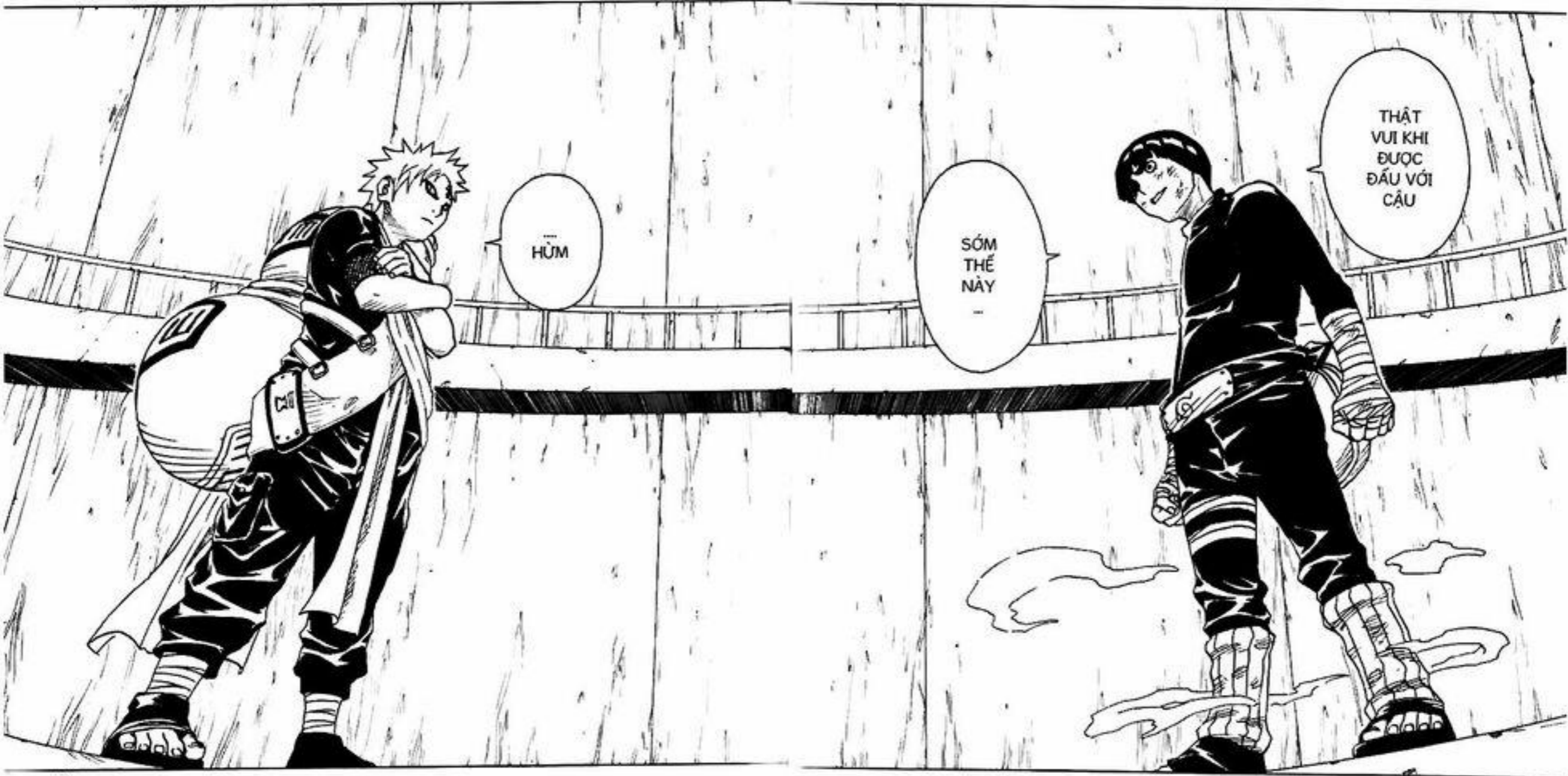

NARUTO

NGUỒN : BLOGTRUYEN.COM

SCAN : NGANKVN
Edit : KYO

CÁC NƠI KHÁC VUI LÒNG :

- GHI RÕ NGUỒN : BLOGTRUYEN.COM
- POST SAU BLOGTRUYEN.COM 2 CHAP
- KHÔNG XÓA-SỬA CREDIT VÀ TRANG TRUYỆN

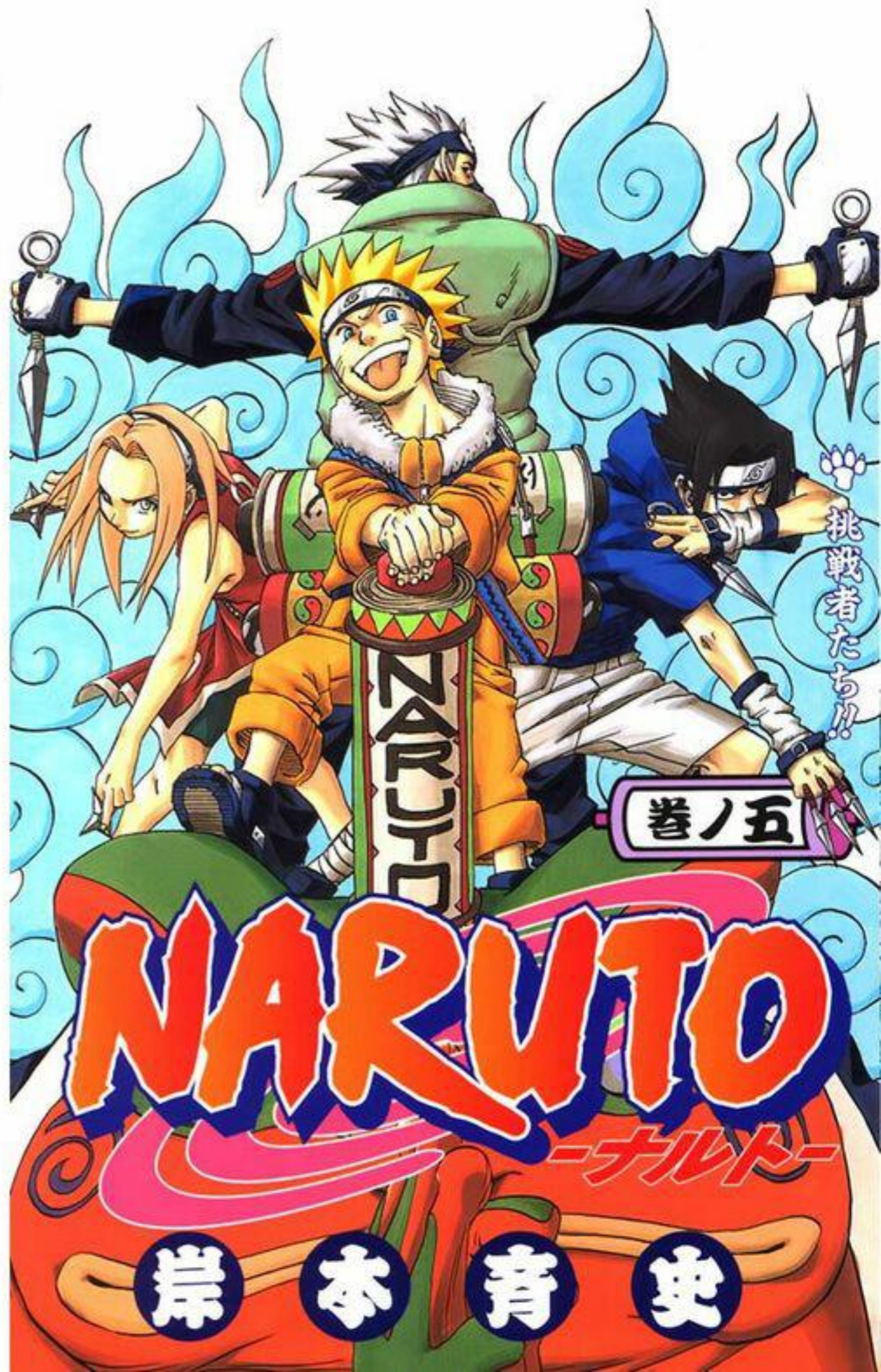



 82 : BÍ MẬT CỦA A-LEE...!!





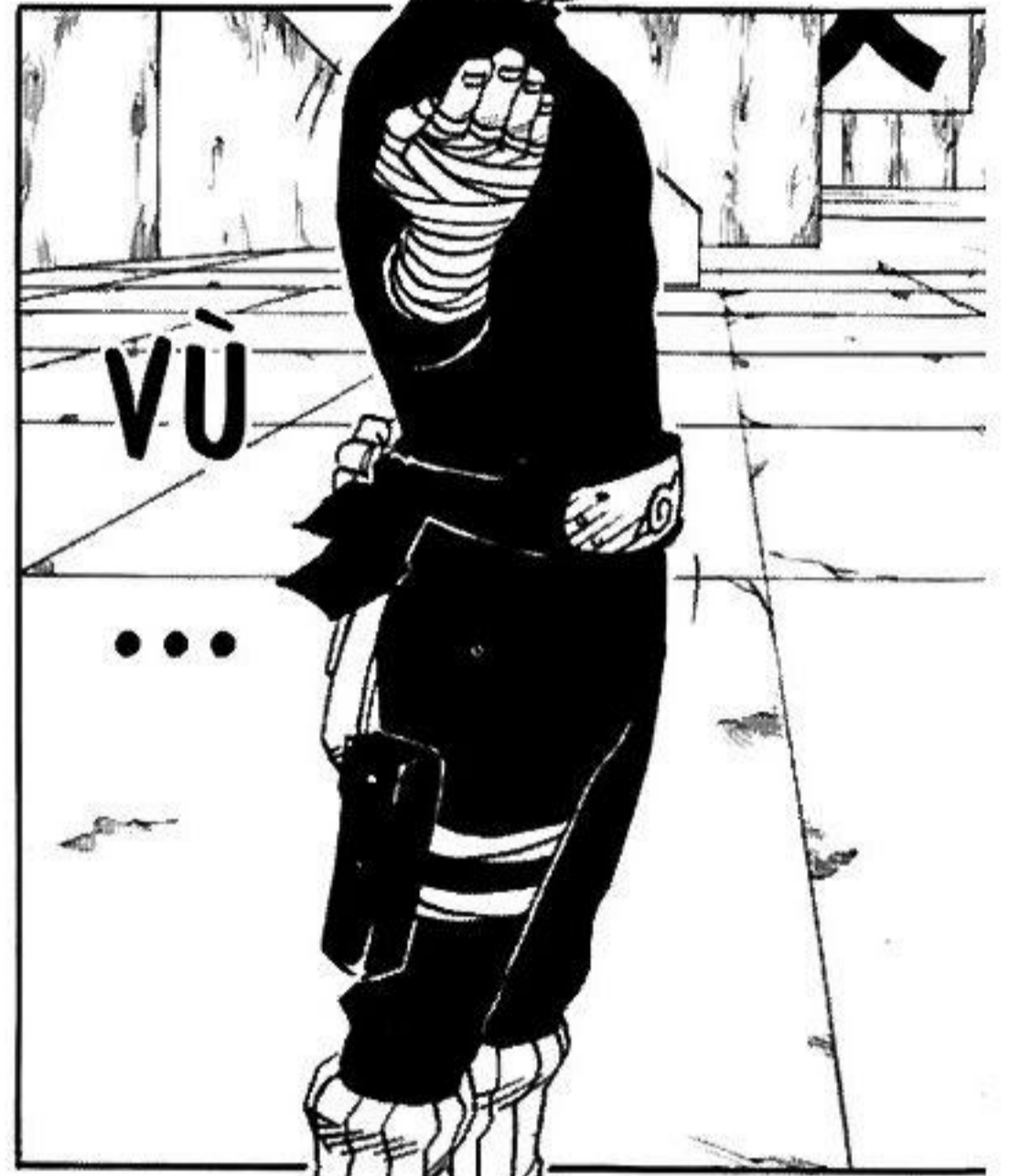
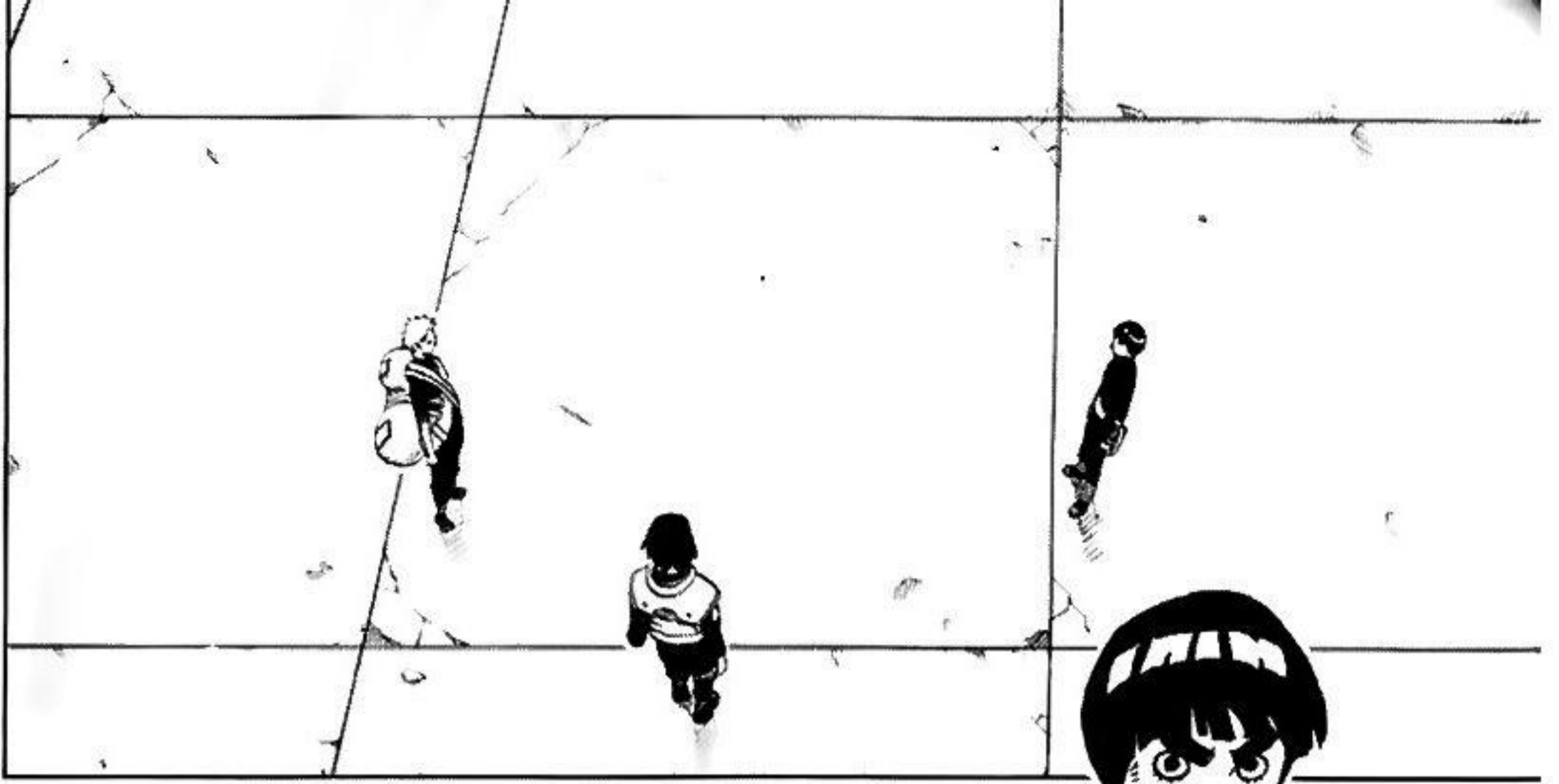

NHUNG CHẮC CHẴN NÓ KHÔNG THẮNG ĐƯỢC GAARA ĐÂU ...

KHÔNG BIẾT CÁI TÊN ĐẦU GÁO DỪA ĐÓ DỪNG ĐÒN TẤN CÔNG GÌ ...

VÙ



KHÔNG ... CẬU ẤY RẤT MẠNH ...







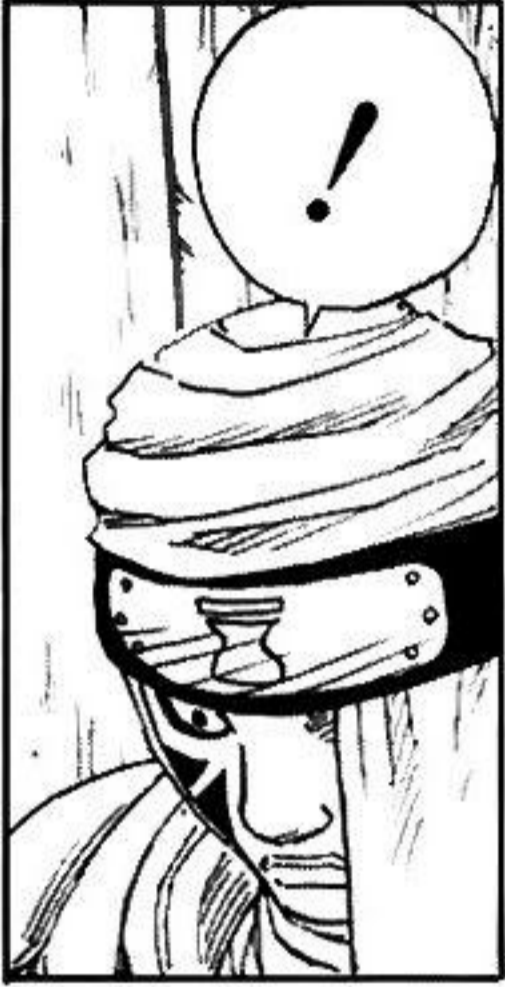

HII...
CHANG
PHAI ĐỐI
THỦ CỦA
GAARA...



TỐC ĐỘ TÊN ĐÓ
CŨNG ĐÓ
NHANH NHƯNG CỨ
ĐÁ LẠI
KHÔNG CÓ
GÌ ĐẶC
BIỆT...



BỘP

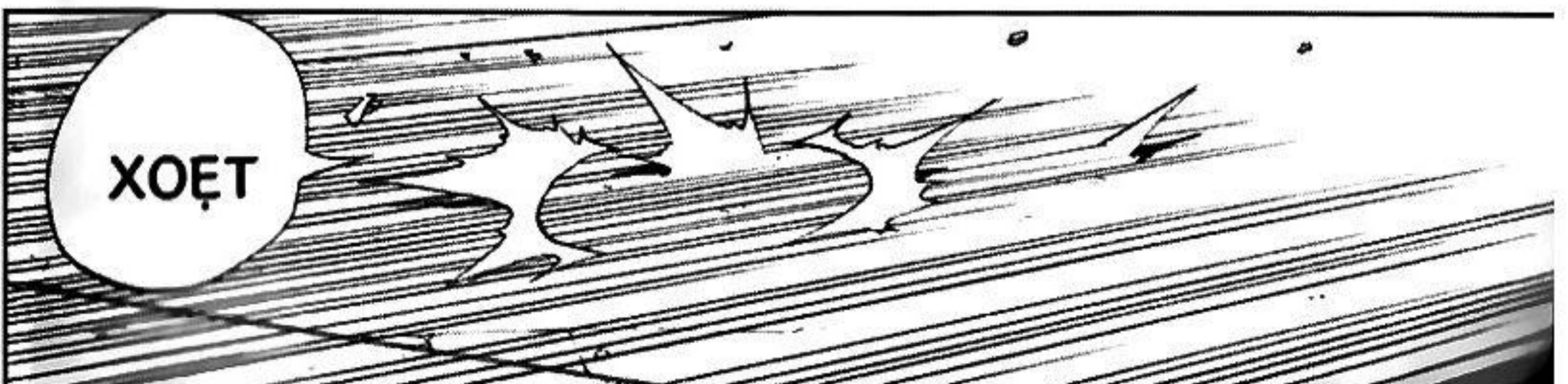

XOẸT



MỘC
DIỆP
TOÀN
PHONG

!!!

BINH

*SAT

*A0000

CÁT

...
!?







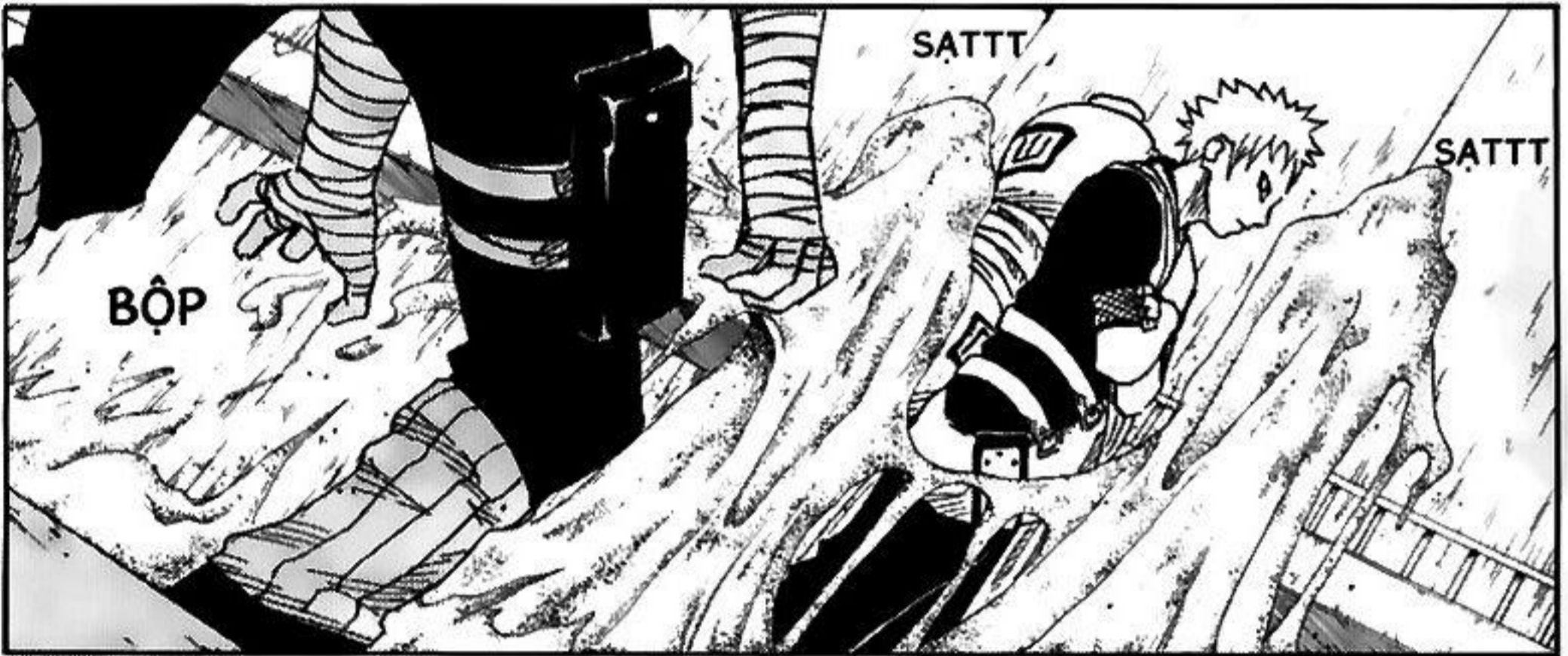

ĐÒN TẤN
CÔNG TỐC ĐỘ
CỦA LEE HOÀN
TOÀN KHÔNG
HIỆU QUẢ ...



HẮN
CHẰNG
THÈM
NHỨC
NHÍCH...











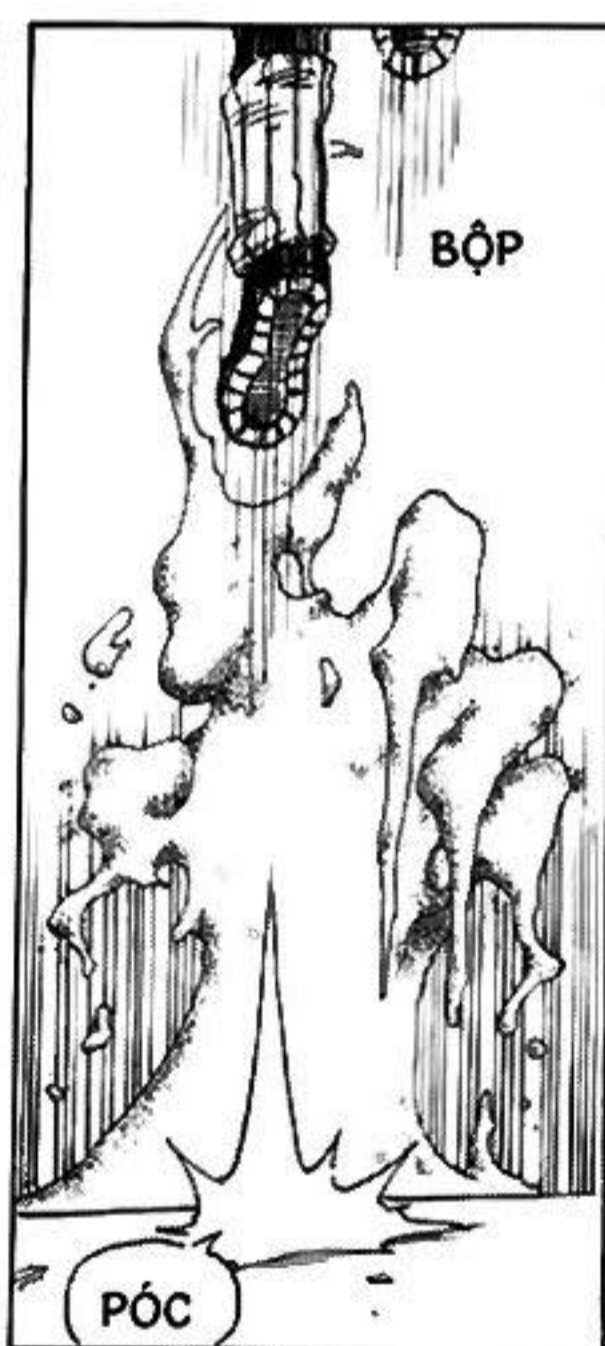
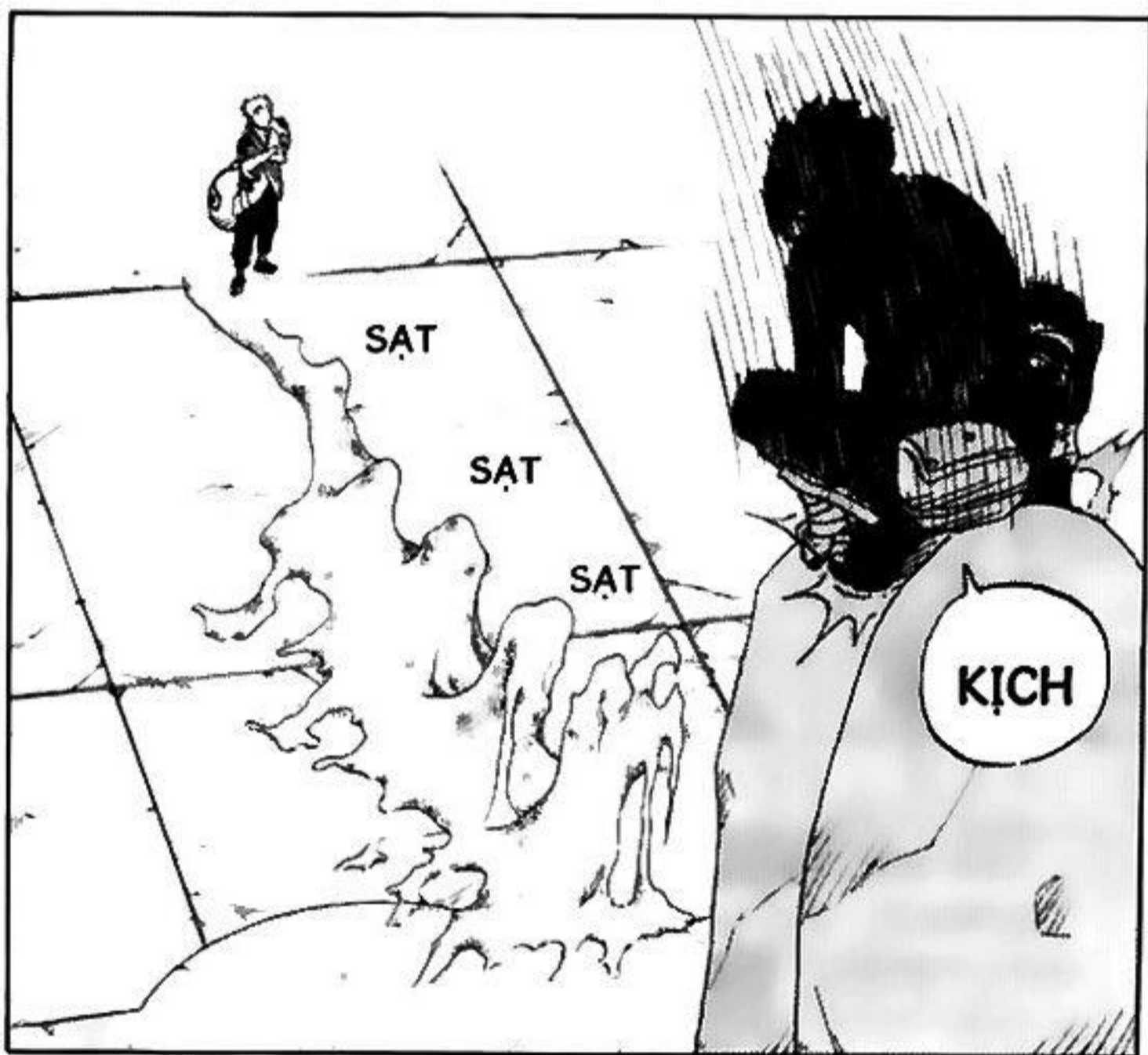



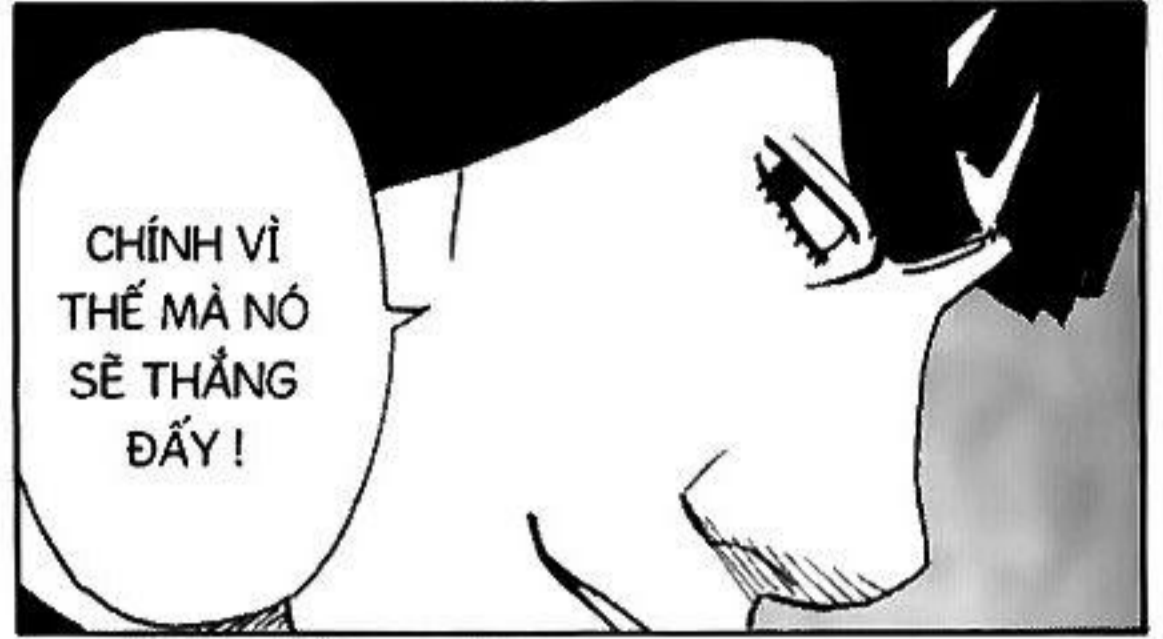







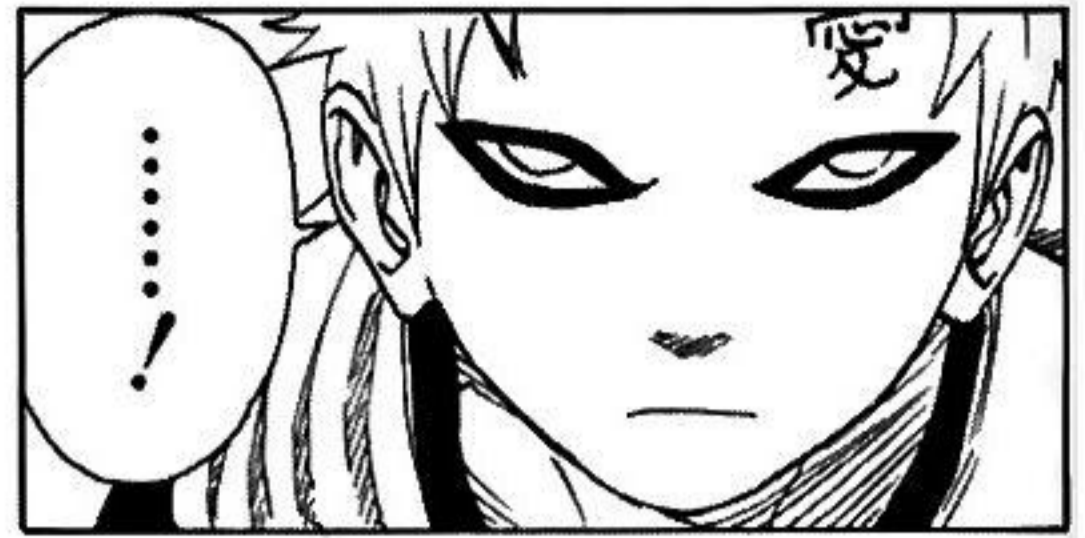







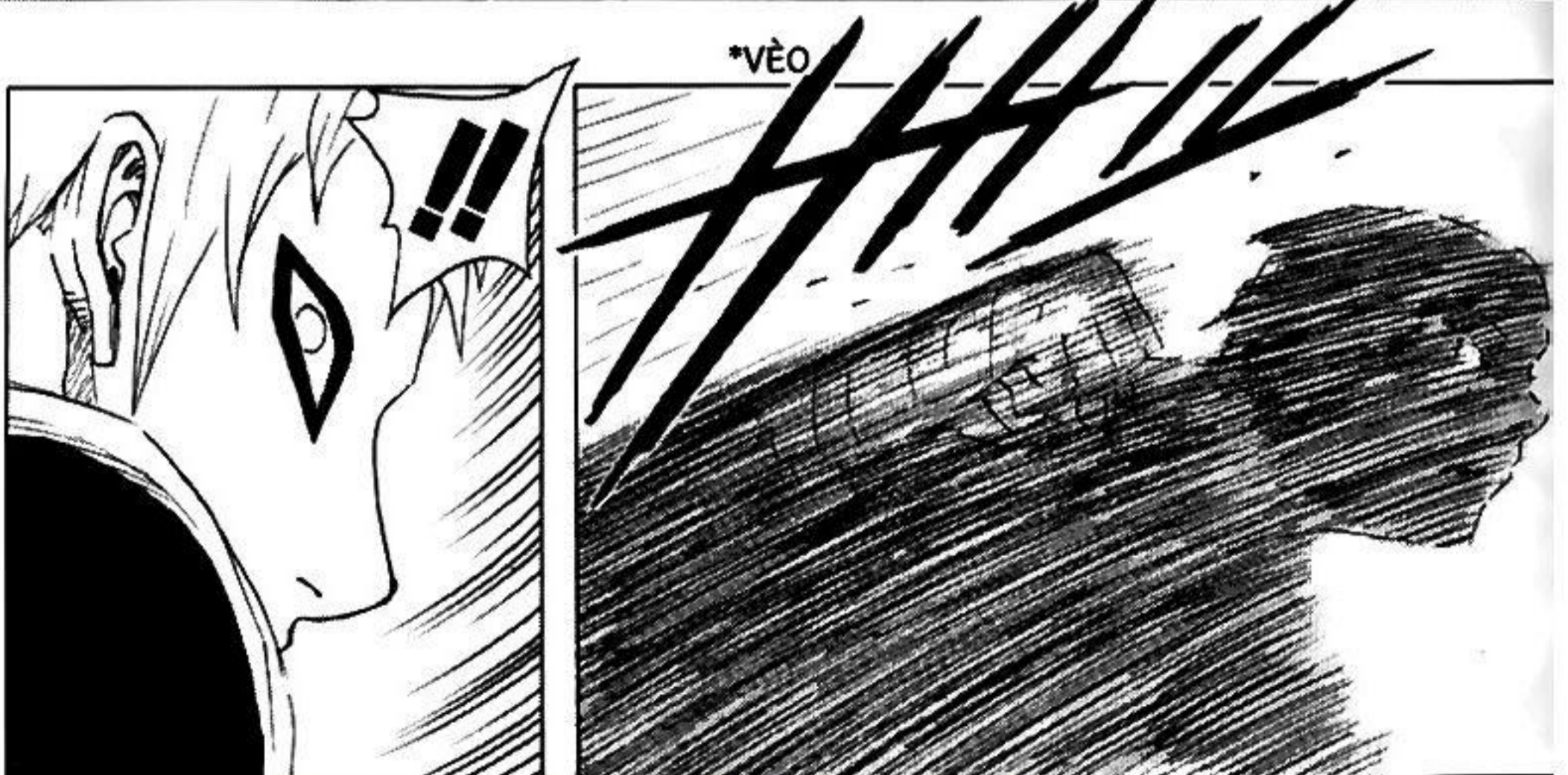



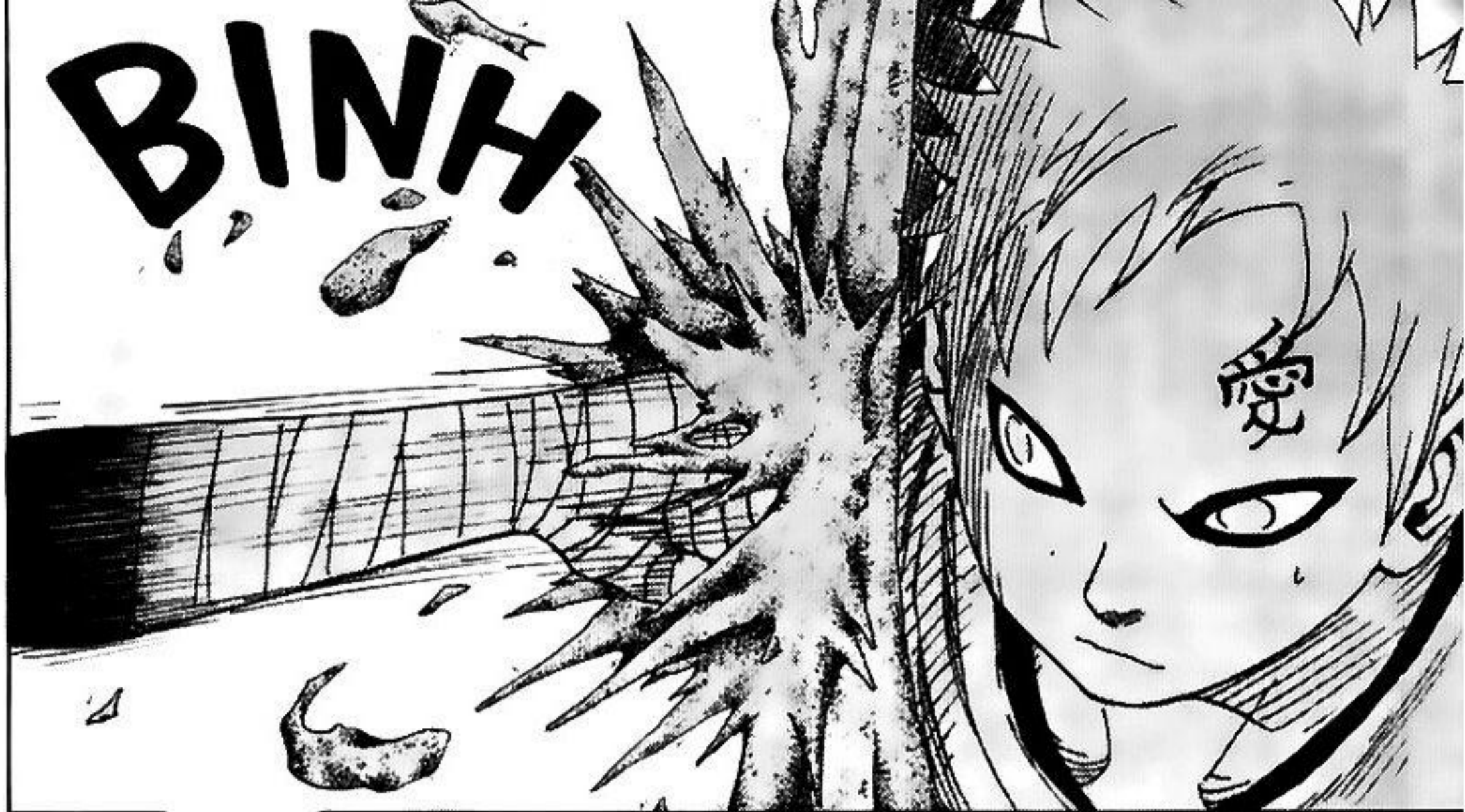







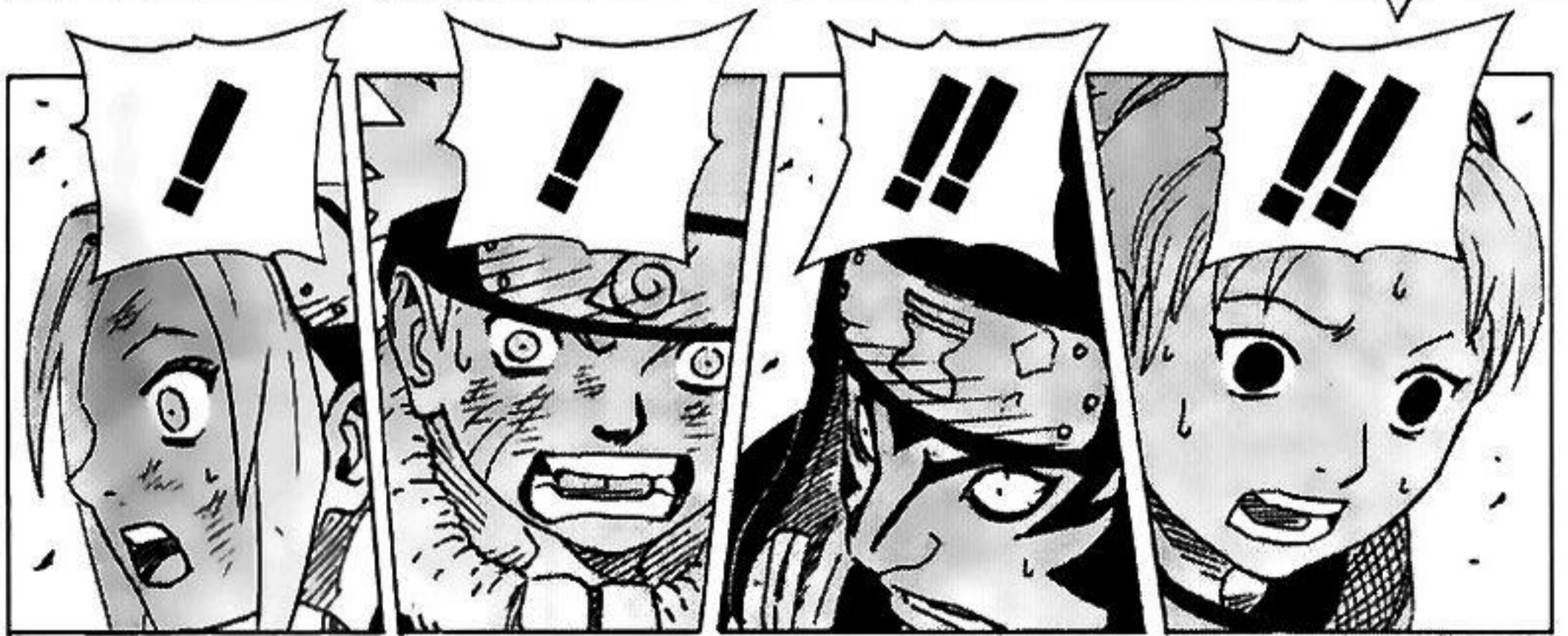











NARUTO

NGUỒN : BLOGTRUYEN.COM

SCAN : NGANKVN
Edit : KYO

CÁC NƠI KHÁC VUI LÒNG :

- GHI RÕ NGUỒN : BLOGTRUYEN.COM
- POST SAU BLOGTRUYEN.COM 2 CHAP
- KHÔNG XÓA-SỬA CREDIT VÀ TRANG TRUYỆN

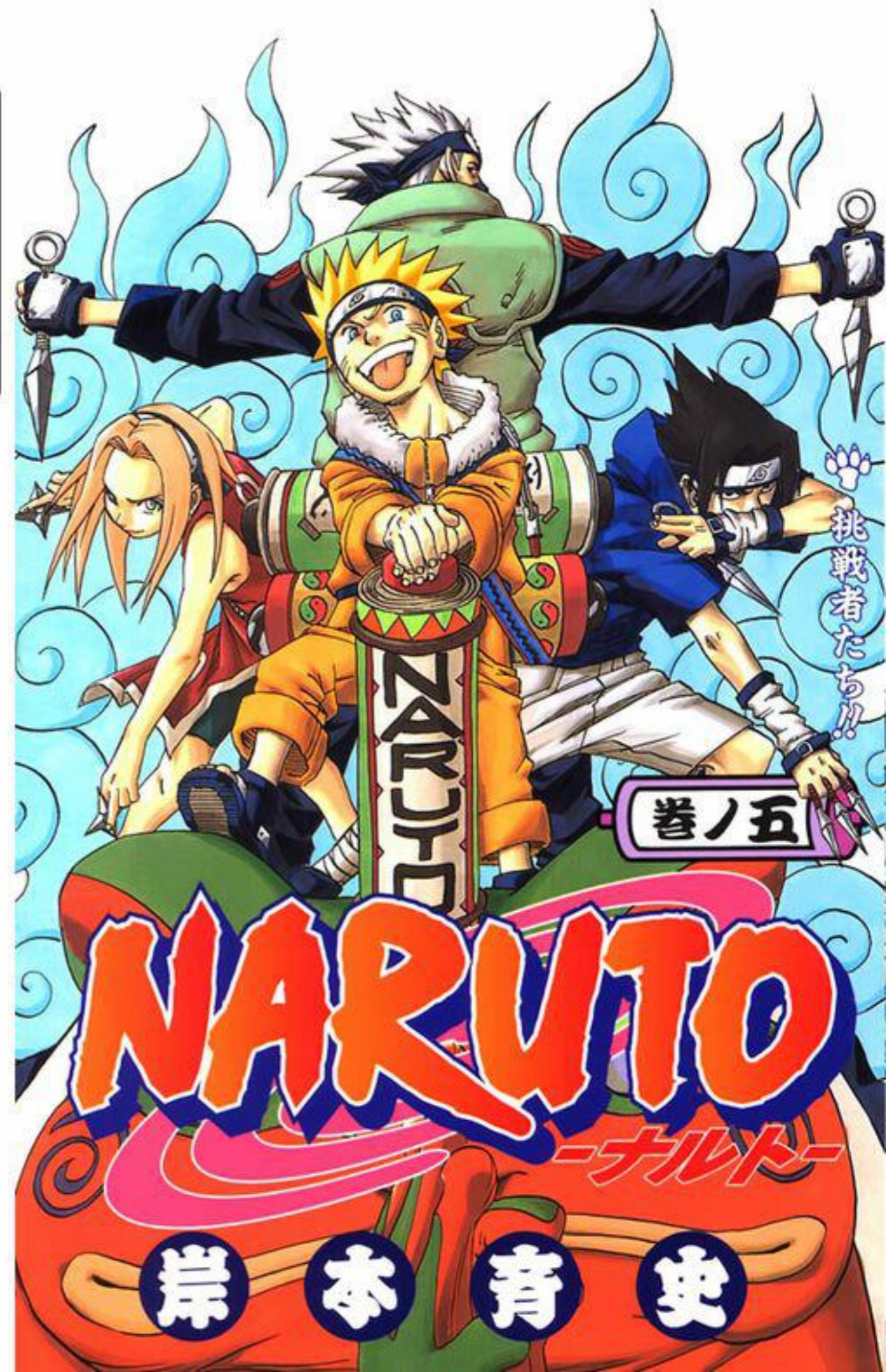

83 : PHÒNG NGỰ TUYỆT ĐỐI

PHÁ VỠ !?



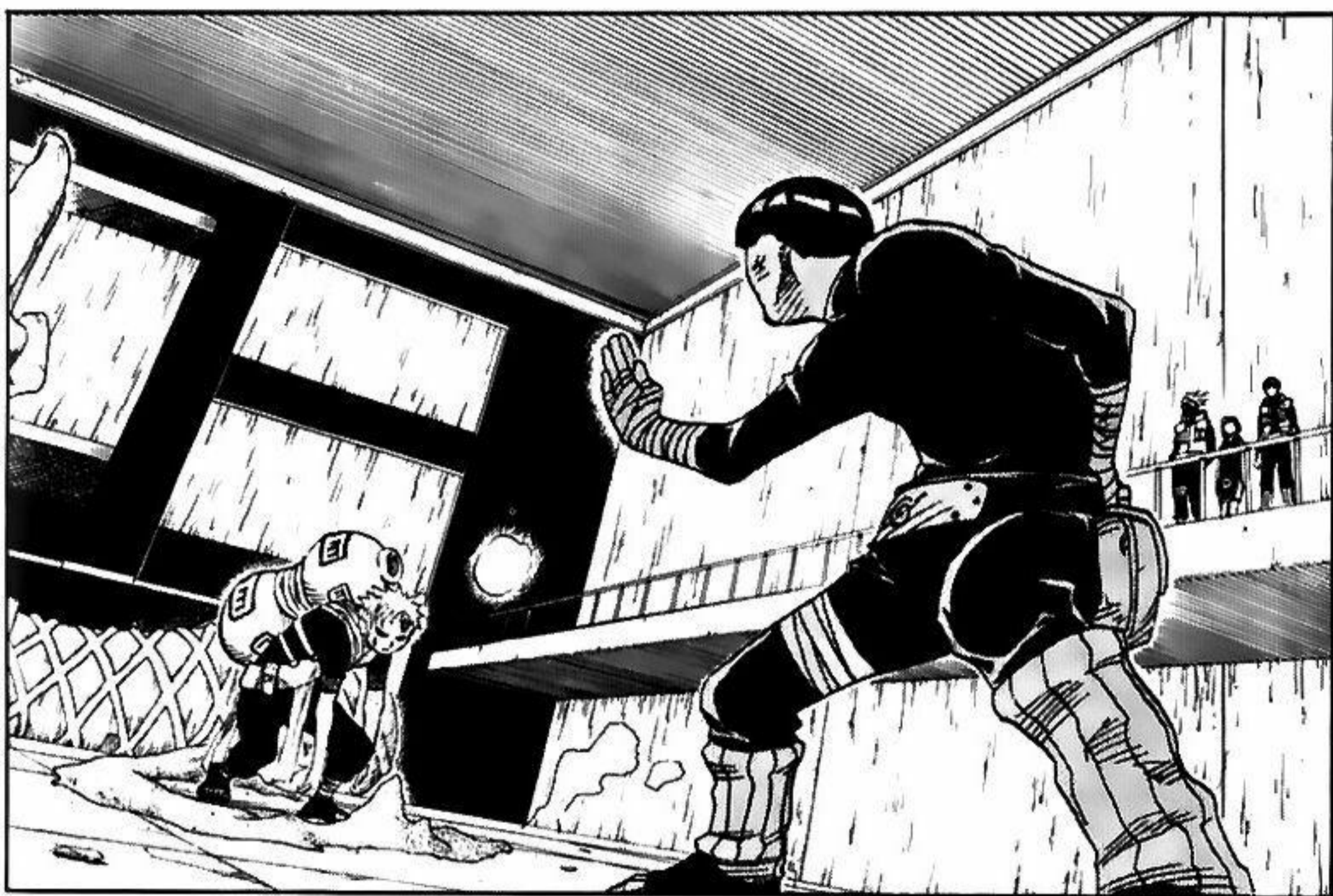







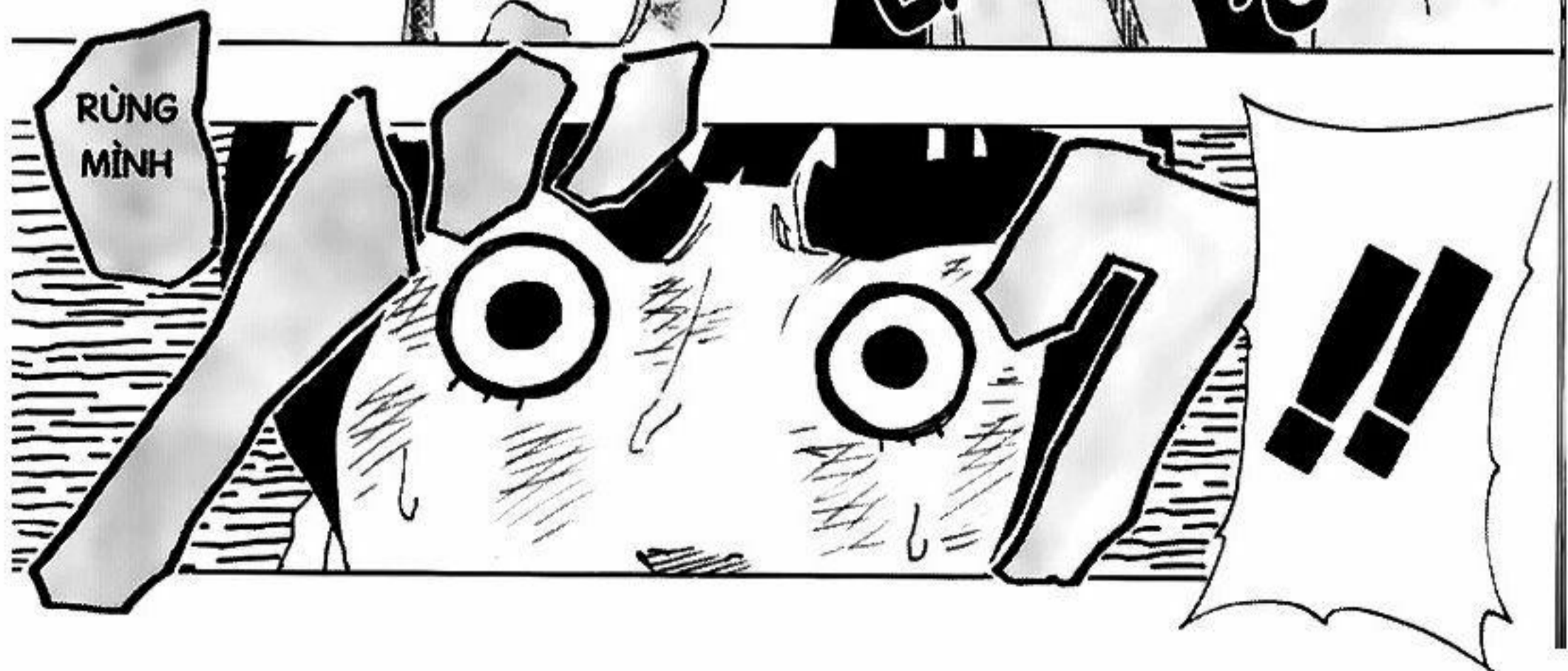





NÓ KHÁC VỚI "TẮM KHIÊN CÁT" THÔNG THƯỜNG CHẢY XUNG QUANH CƠ THỂ VÀ TỰ ĐỘNG BẢO VỆ CHỦ THỂ ...

ĐÚNG VẬY ... "ÁO GIÁP CÁT" LÀ MỘT BỨC TƯỜNG PHÒNG NGỰ CỰC MỎNG BAO BỌC CƠ THỂ DO GAARA DÙNG Ý CHÍ ĐIỀU KHIỂN ...

TẮM KHIÊN CÁT

ÁO GIÁP CÁT

ÁO GIÁP ...?

KHÔNG THỂ LÀM ĐƯỢC GÌ NÓ SAO!

BỘ NÓ KHÔNG CÓ NHƯỢC ĐIỂM HẢ ...!

PHÒNG NGỰ TUYỆT ĐỐI CỦA GAARA ...!

NÓ LÀ THỨ ...

GAARA KHÔNG SỬ DỤNG NÓ BAO GIỜ NGOẠI TRỪ NHỮNG TÌNH HUỐNG CẤP BÁCH ...

KHÔNG ... TUY KHÔNG THỂ NÓI CHẮC CHẮN... NHƯNG CÁI "ÁO GIÁP CÁT" ĐÓ NGƯỢC LẠI MỚI CHÍNH LÀ NHƯỢC ĐIỂM ...!



HƠN NỮA, VÌ
CÁT BAO
QUANH CƠ
THỂ LÀM CƠ
THỂ NẶNG
HƠN NÊN
PHẢI HAO
TỐN RẤT
NHIỀU THỂ
LỰC ...

VÀ BẢO
VỆ KHÔNG
TỐT
BẰNG
"TẮM
KIÊN CÁT"

VÌ KHÔNG
CÒN TỰ
ĐỘNG NÊN
NÓ TIÊU
PHÍ 1
LƯỢNG
CHAKRA
CỰC LỚN
...



NHUNG
THẬT RA
THẮNG
BAI ĐÃ
RÕ RỜI
...

TÊN LEE
ĐÓ ...
ĐÚNG LÀ
KHẢ THẬT
ĐẤY ...



NÓ BUỘC
PHẢI VÀO
THỂ
PHÒNG
NGỰ ...!

GAARA
BUỘC
PHẢI
DỪNG TỚI
NÓ,
CHÚNG TỎ
....



CHỈ CÓ VẬY
THÔI SAO
...



BỞI VÌ ...
GAARA
CHÍNH LÀ
MỘT THIÊN
TÀI !!



THẾ NÀY THÌ
CHỈ CÒN CÁCH
DÙNG ĐÒN TẤN
CÔNG MẠNH
HƠN CẢ LỰC
PHÒNG NGỰ
CỦA CÁT MÀ
THÔI ...!

LÀ LOẠI PHÒNG
NGỰ GÌ THẾ NÀY
...
MÌNH CÓ DÙNG
ĐÒN TẤN CÔNG
NHANH THẾ NÀO
CŨNG ĐỀU BỊ NÓ
ĐỔ HẾT







THỂ
THEO
NGUYỄN
VỌNG
!

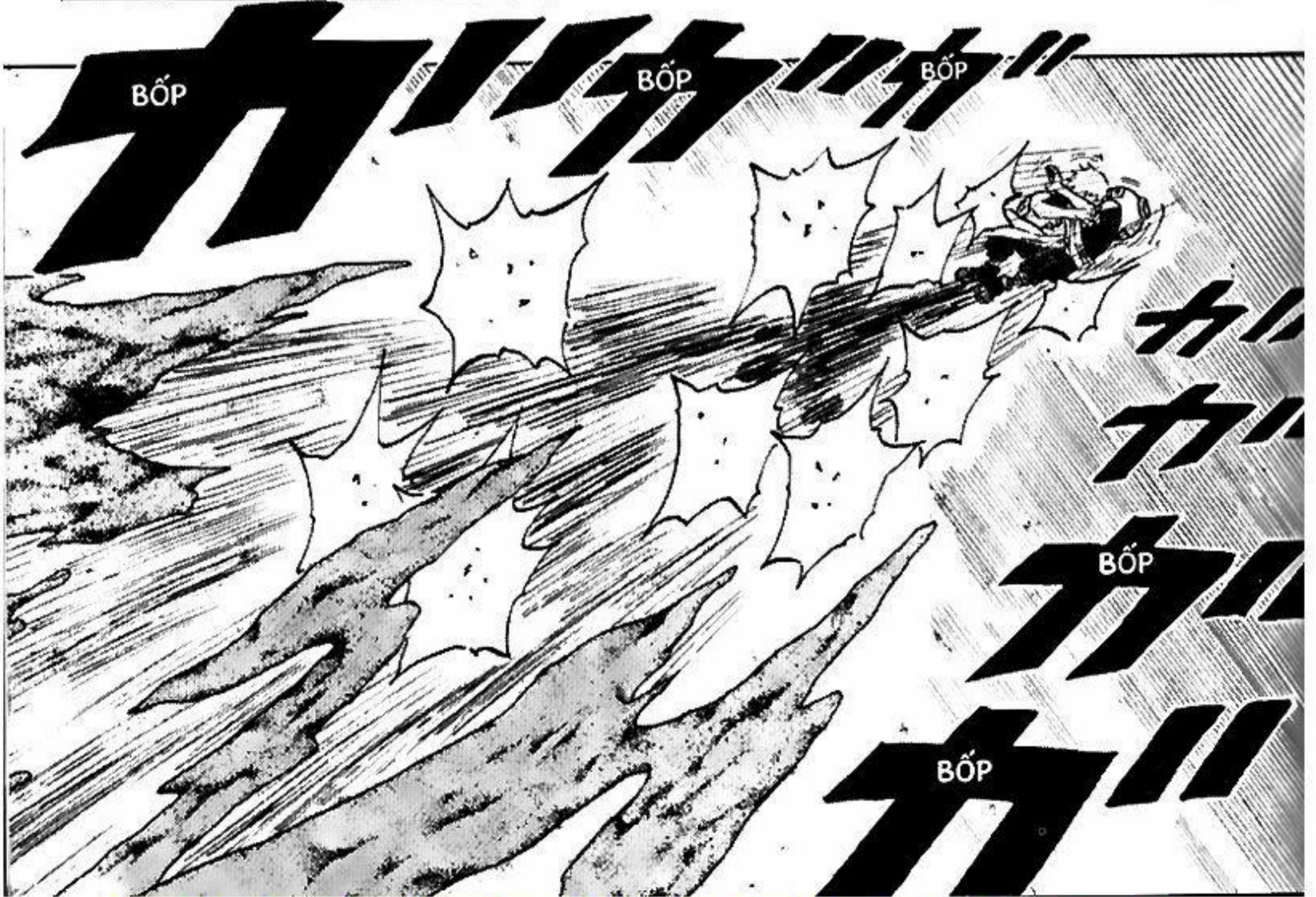
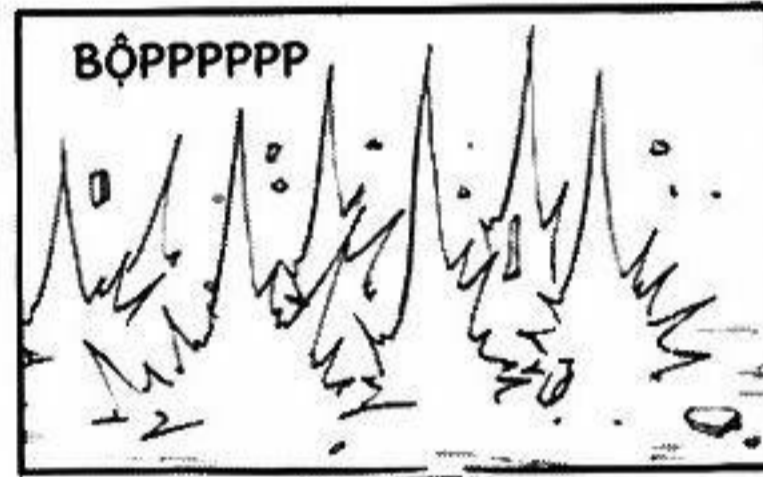

NHUNG CÒN
CHIỀU NÀY THÌ
KHẢ NGUY HIỂM
CHO LEE...
ĐÂY LÀ CHIỀU
QUYẾT ĐỊNH ĐÓ
LEE!

NẾU LÀ CHIỀU
LIÊN HOA BÌNH
THƯỜNG THÌ
KHÔNG ĐỀ
NĂNG LÊN CƠ
THỂ LẮM



*ĐAU NHÓI

A
...





XOÁY

BIỂU
LIÊN
HOA
!!!



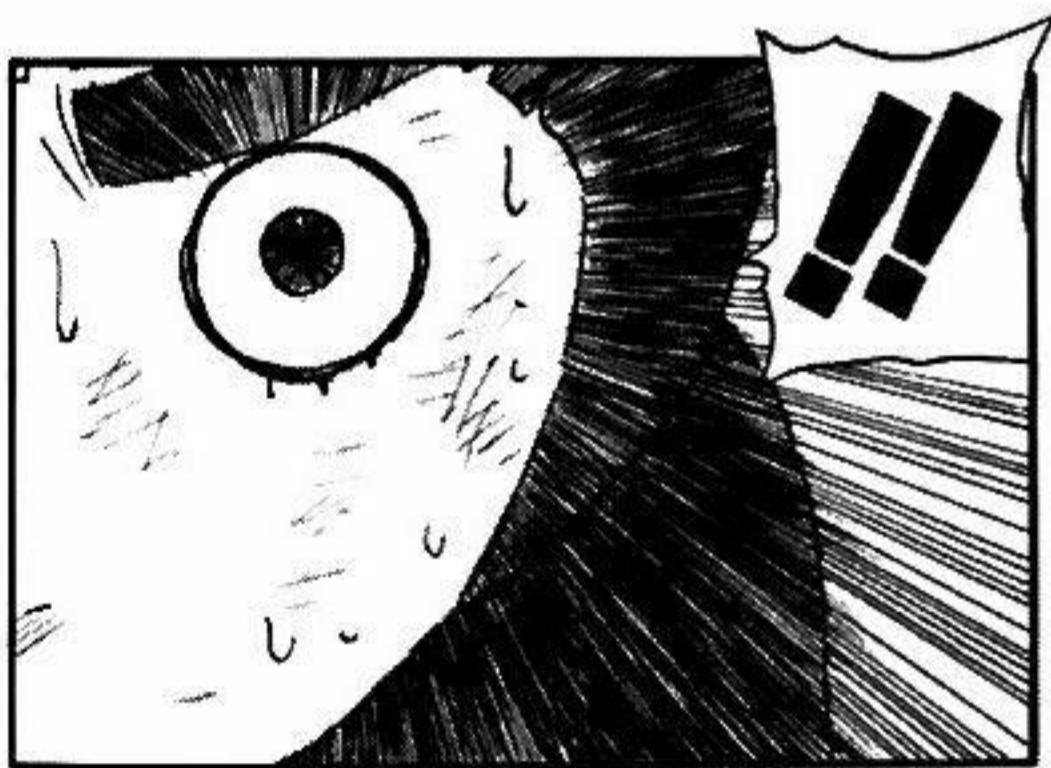
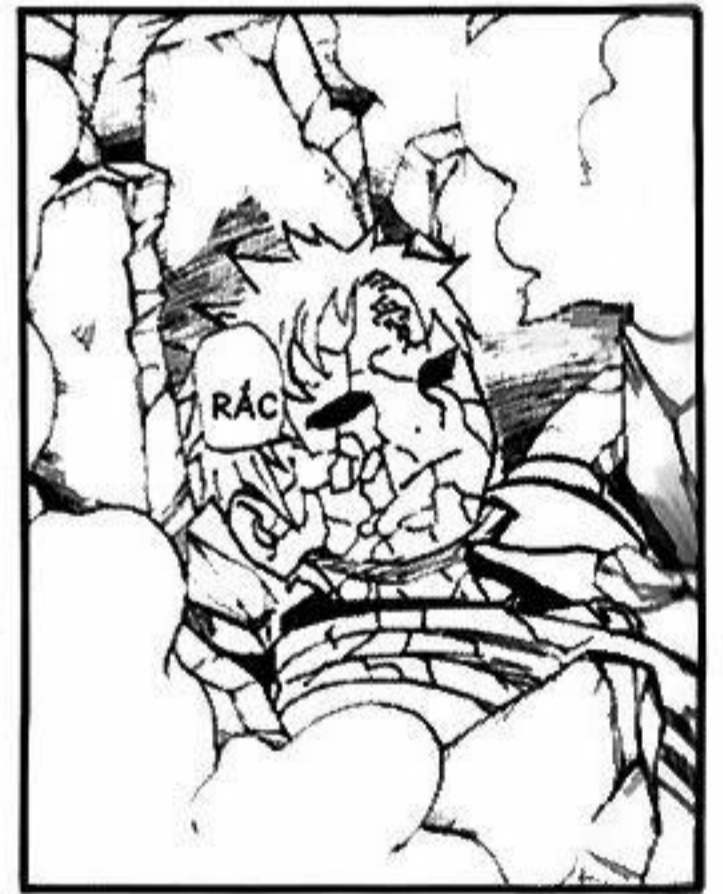



LÚC NGƯỜI NHẢM MẮT CẦU NGUYỆN ĐẤY, GUY ...



NÓ THOÁT KHỎI TẮM KHIÊN CÁT TỪ KHI NÀO ...



NARUTO

NGUỒN : BLOGTRUYEN.COM

SCAN : NGANKVN
Edit : KYO

CÁC NƠI KHÁC VUI LÒNG :

- GHI RÕ NGUỒN : BLOGTRUYEN.COM
- POST SAU BLOGTRUYEN.COM 2 CHAP
- KHÔNG XÓA-SỬA CREDIT VÀ TRANG TRUYỀN

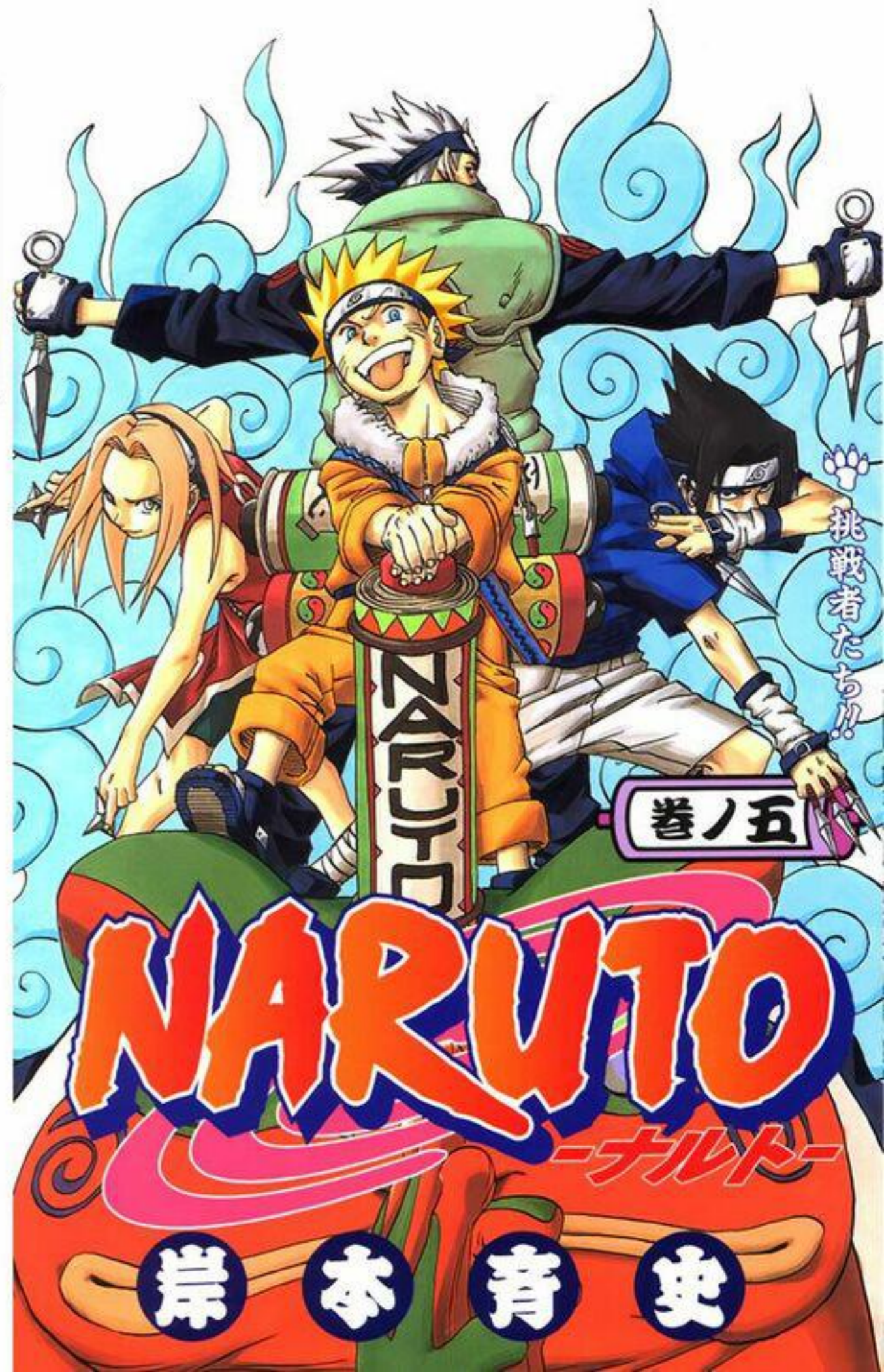

84 : THIÊN TÀI NỖ LỰC ...!!

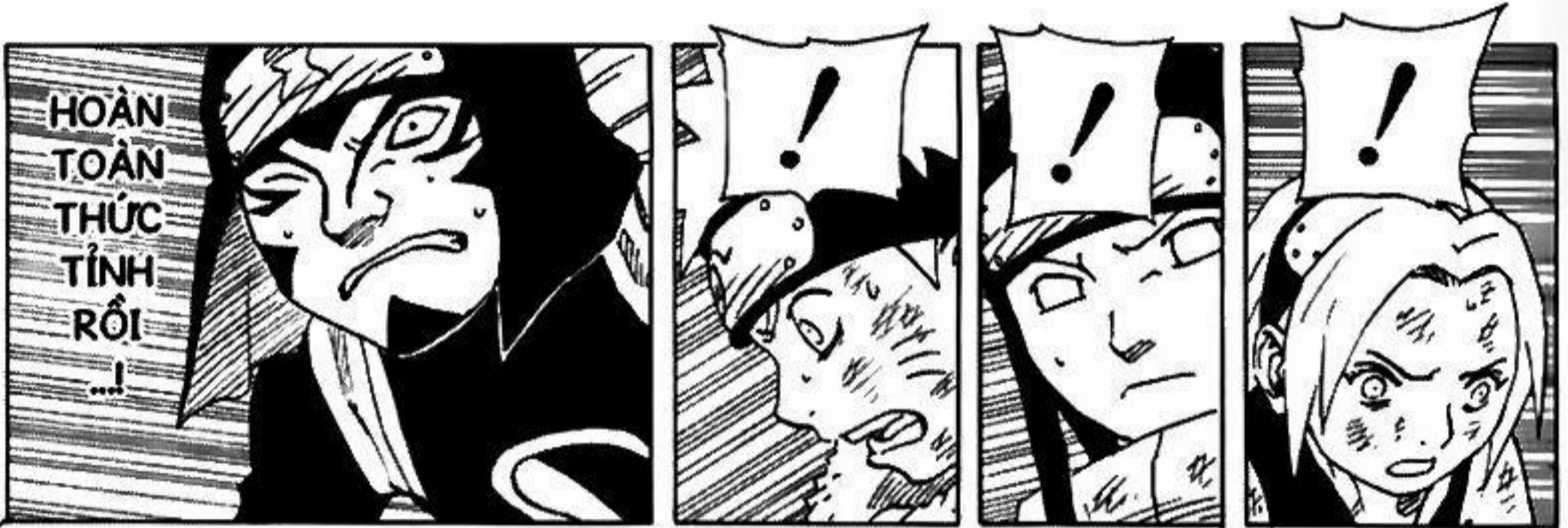

84 :

THIÊN TÀI NỔ LỰC ...!!



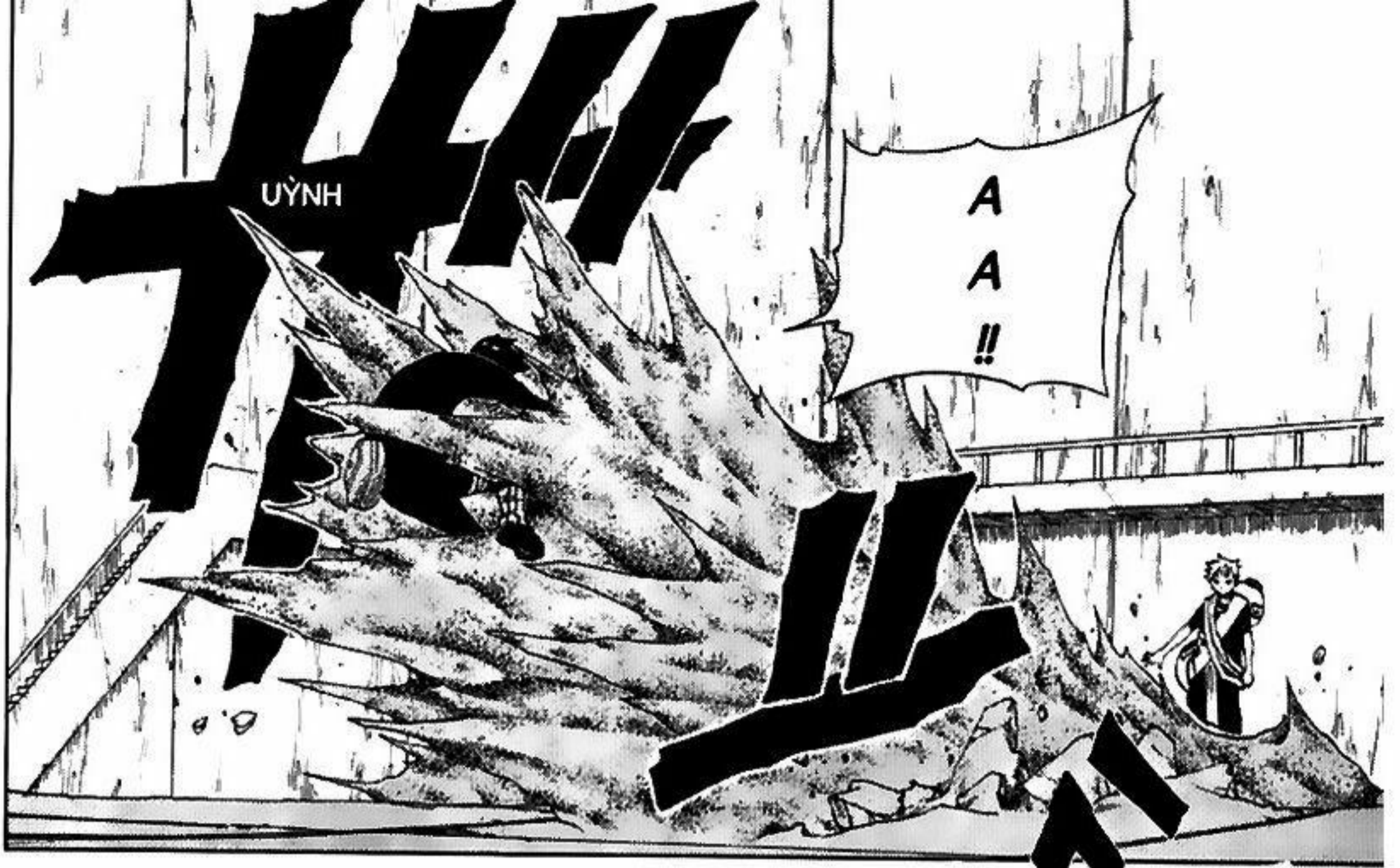





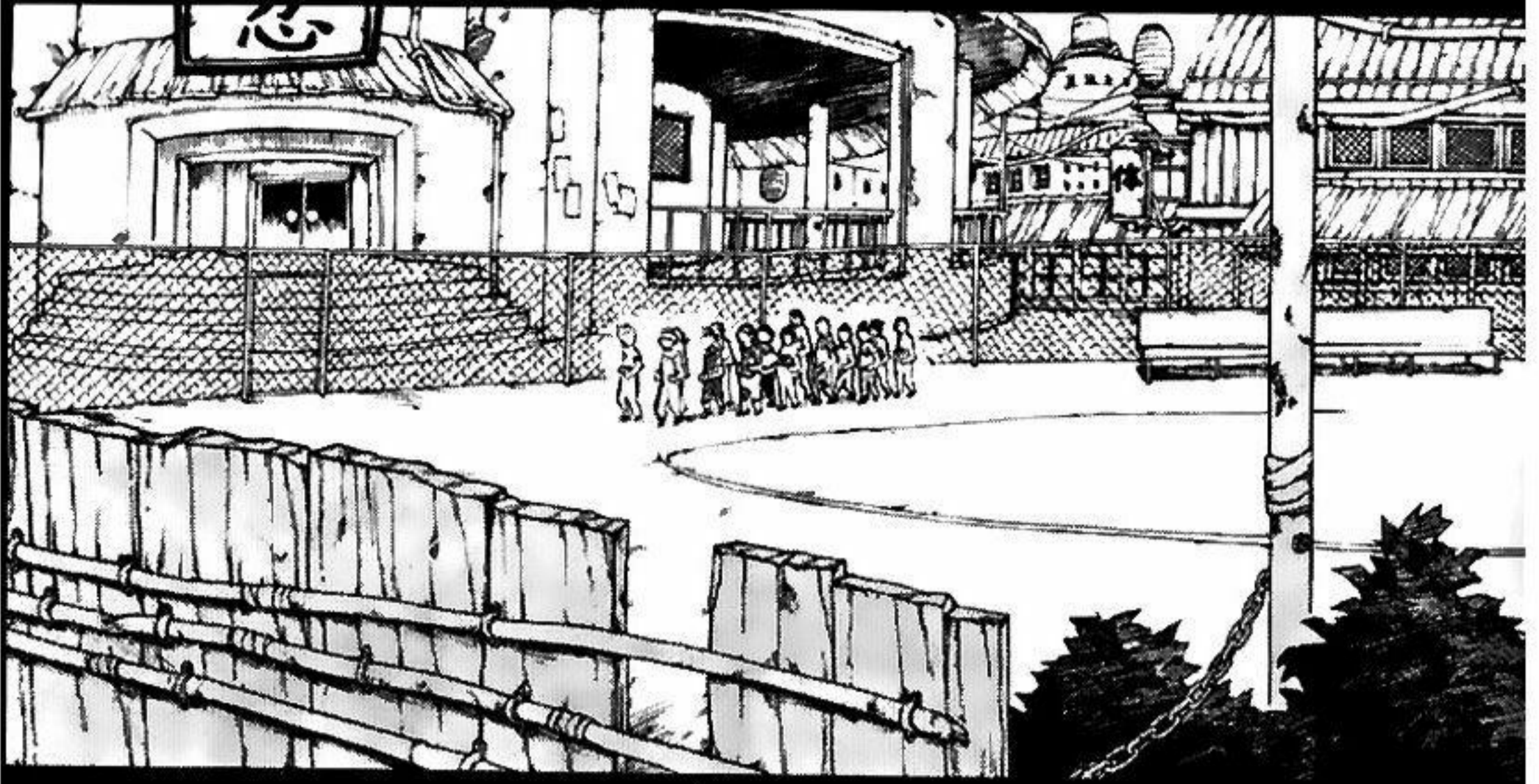



BỘP
ê, Lee !!
vô hàng
coi !!



A
A
A

HAY



BIỆT DANH
LÀ "KẺ BẠI
TRẬN NHIỆT
HUYẾT" ĐÂY
MÀ ...

HI HI ...
THẰNG BÉ
HỌC SINH
MỚI ĐÓ
...



LUYỆN TẬP
KHÔNG
NGỪNG
CÁI THỂ
THUẬT
TRUNG BÌNH
ĐÓ ...
VÀ ...

NHUNG
EM ĐÃ
CHĂM
CHỈ
...



A
A
A



THẦY MUỐN
NGHE THỦ
MỤC TIÊU
CỦA CÁC EM
THẾ NÀO

TỪ BÂY GIỜ
CÁC EM ĐÃ
TRỞ THÀNH
GENIN !



HỪM ...



KHÔNG THÍCH TRẢ LỜI ...



THUA THẤY !!

giật



GIỐNG NHƯ TSUNADE SAMA TRONG TRUYỀN THUYẾT ...

EM THÌ MUỐN TRỞ THÀNH MỘT NINJA MẠNH MẼ ...



ĐÓ CHÍNH LÀ MỤC TIÊU CỦA EM !!

CŨNG CÓ THỂ TRỞ THÀNH MỘT NINJA KIỆT XUẤT !

EM MUỐN CHỨNG MINH CHO MỌI NGƯỜI THẤY, DÙ KHÔNG SỬ DỤNG ĐƯỢC NHẮN THUẬT VÀ ẢO THUẬT



CÓ GÌ ĐÁNG CƯỜI ĐÁU HẢ !!!

CHỈ

HỪ



ĐƯỢC LẮM +



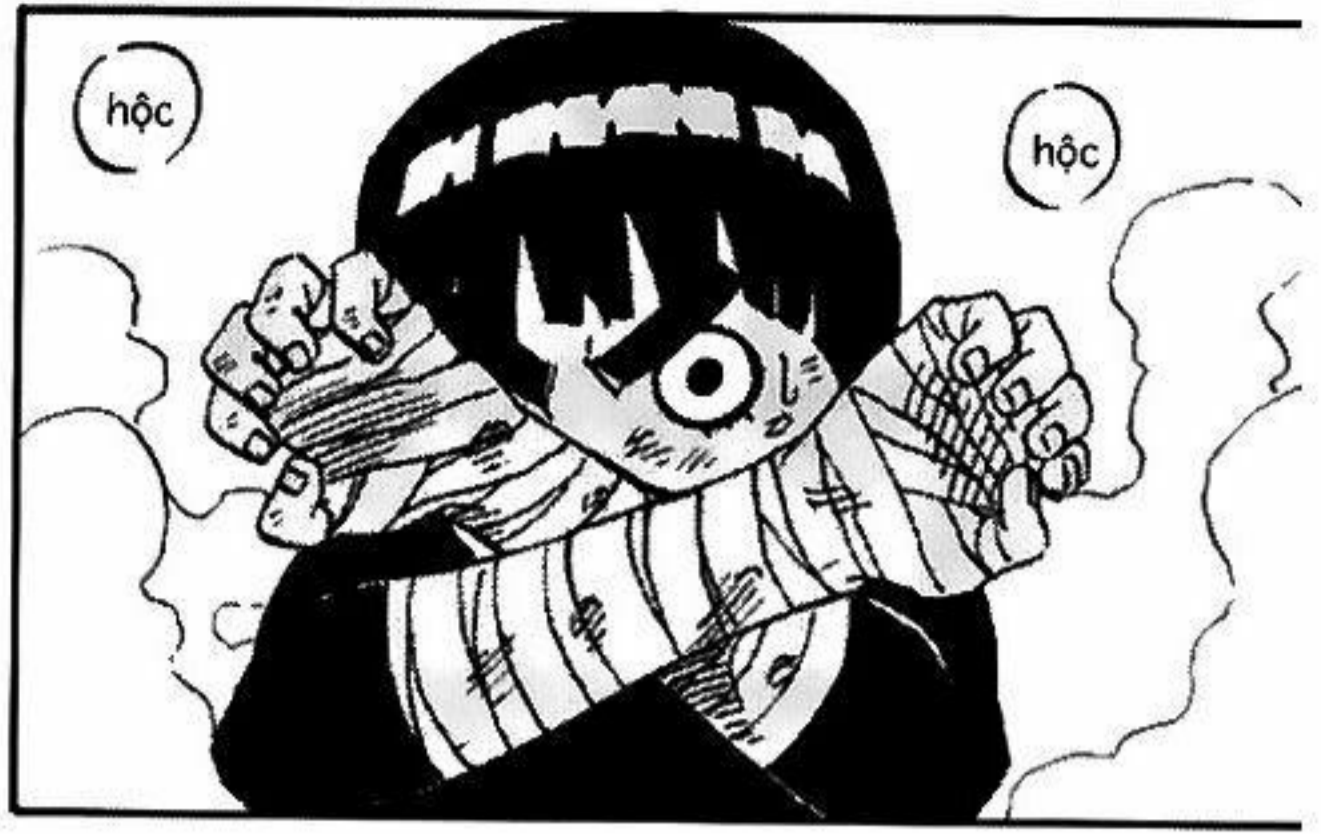

NẾU HÍT ĐẤT
LIÊN TIẾP 500 CÁI
KHÔNG ĐƯỢC THÌ
MÌNH SẼ TẬP
NHẢY DÂY 1200
CÁI ...!



BẶC



1116
...
1117
...

A!



VÙ

PUNG

PUNG



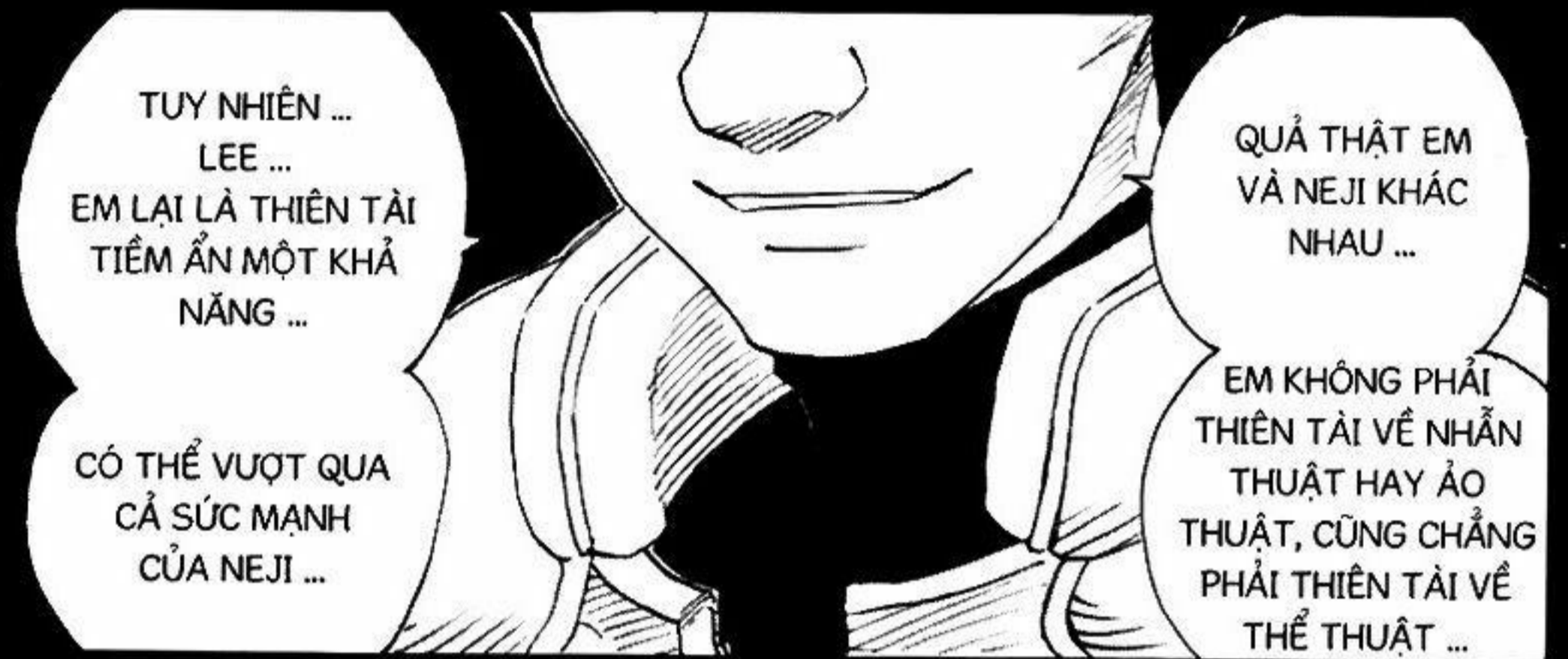





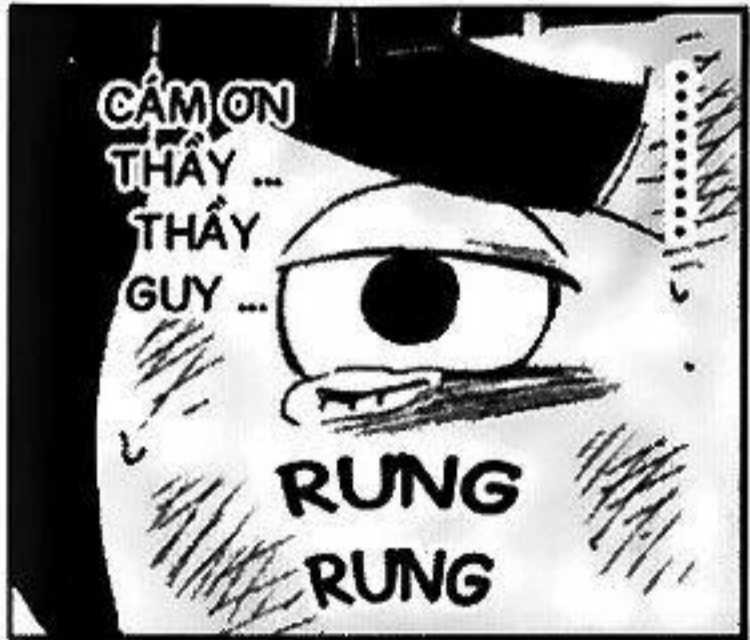









NARUTO

NGUỒN : BLOGTRUYEN.COM

SCAN : NGANKVN
Edit : KYO

CÁC NƠI KHÁC VUI LÒNG :

- GHI RÕ NGUỒN : BLOGTRUYEN.COM
- POST SAU BLOGTRUYEN.COM 2 CHAP
- KHÔNG XÓA-SỬA CREDIT VÀ TRANG TRUYỆN

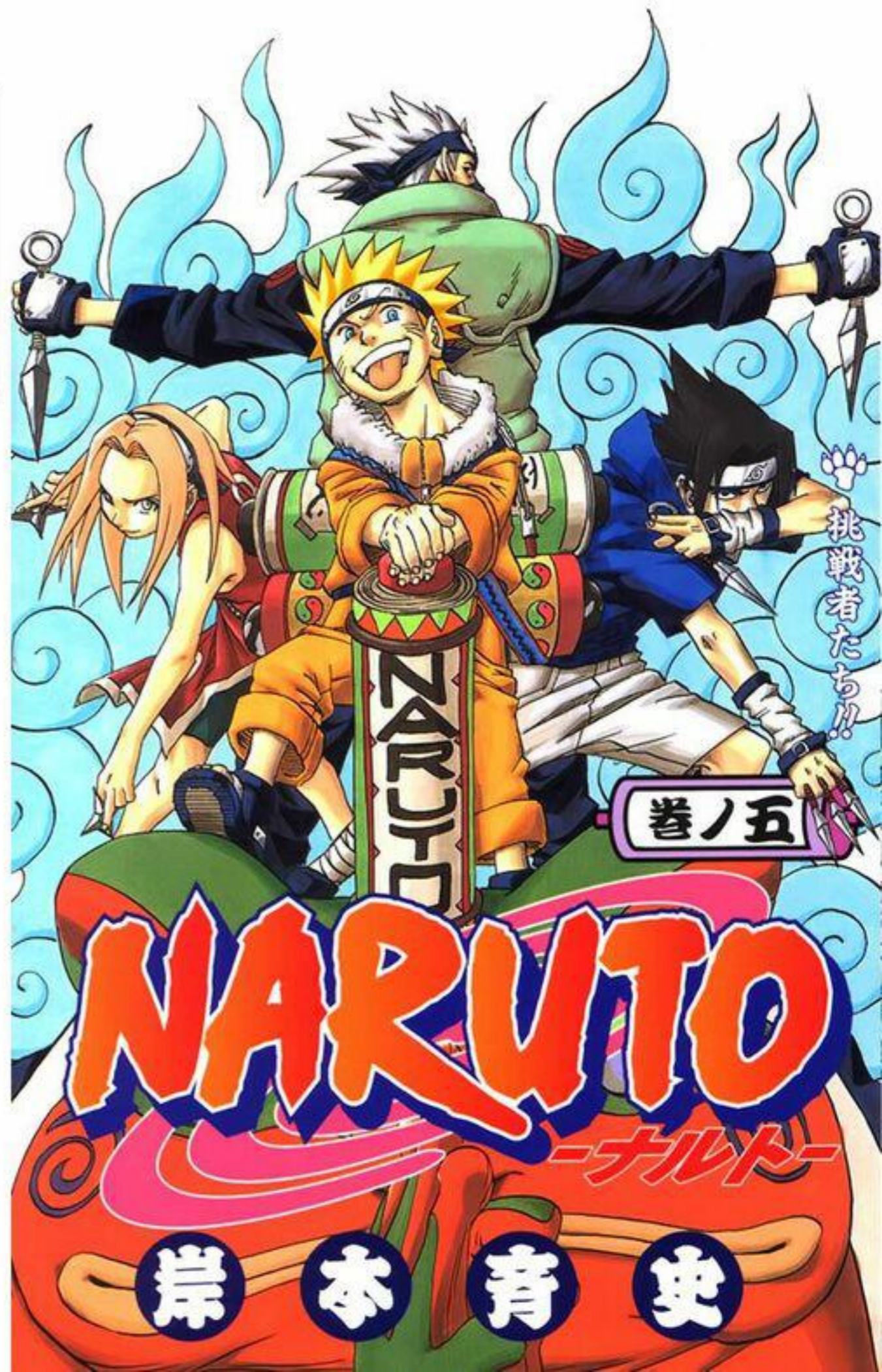



 85 :

GIỜ CHÍNH LÀ LÚC ...!!





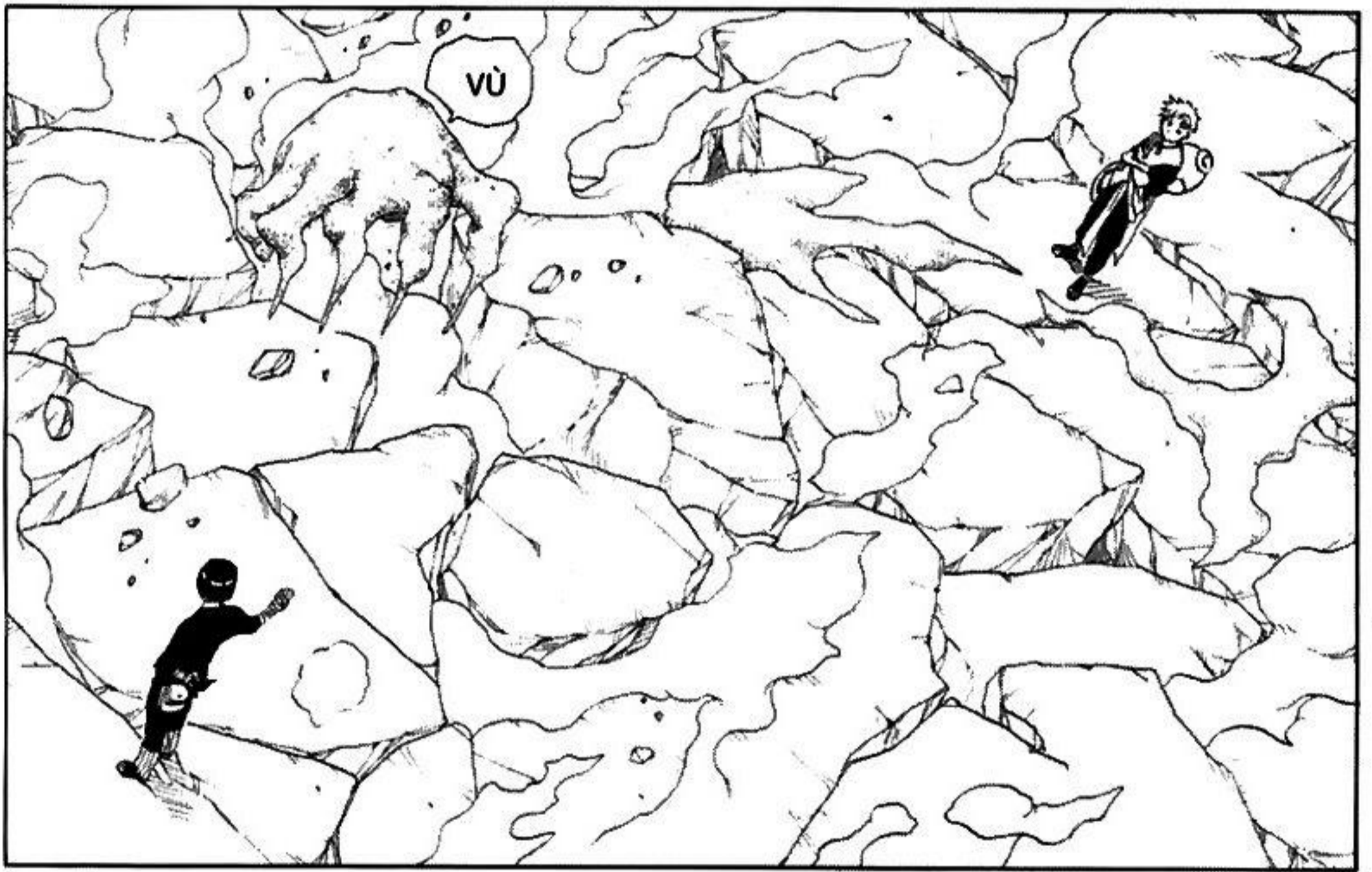















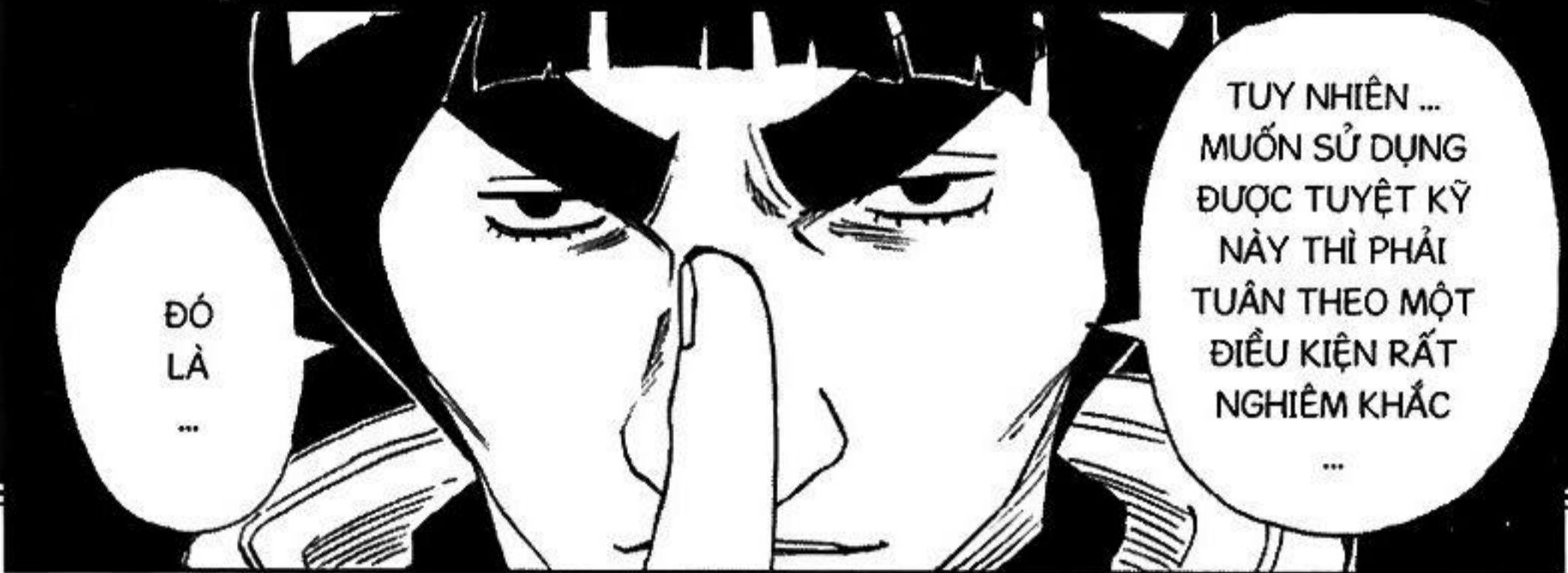



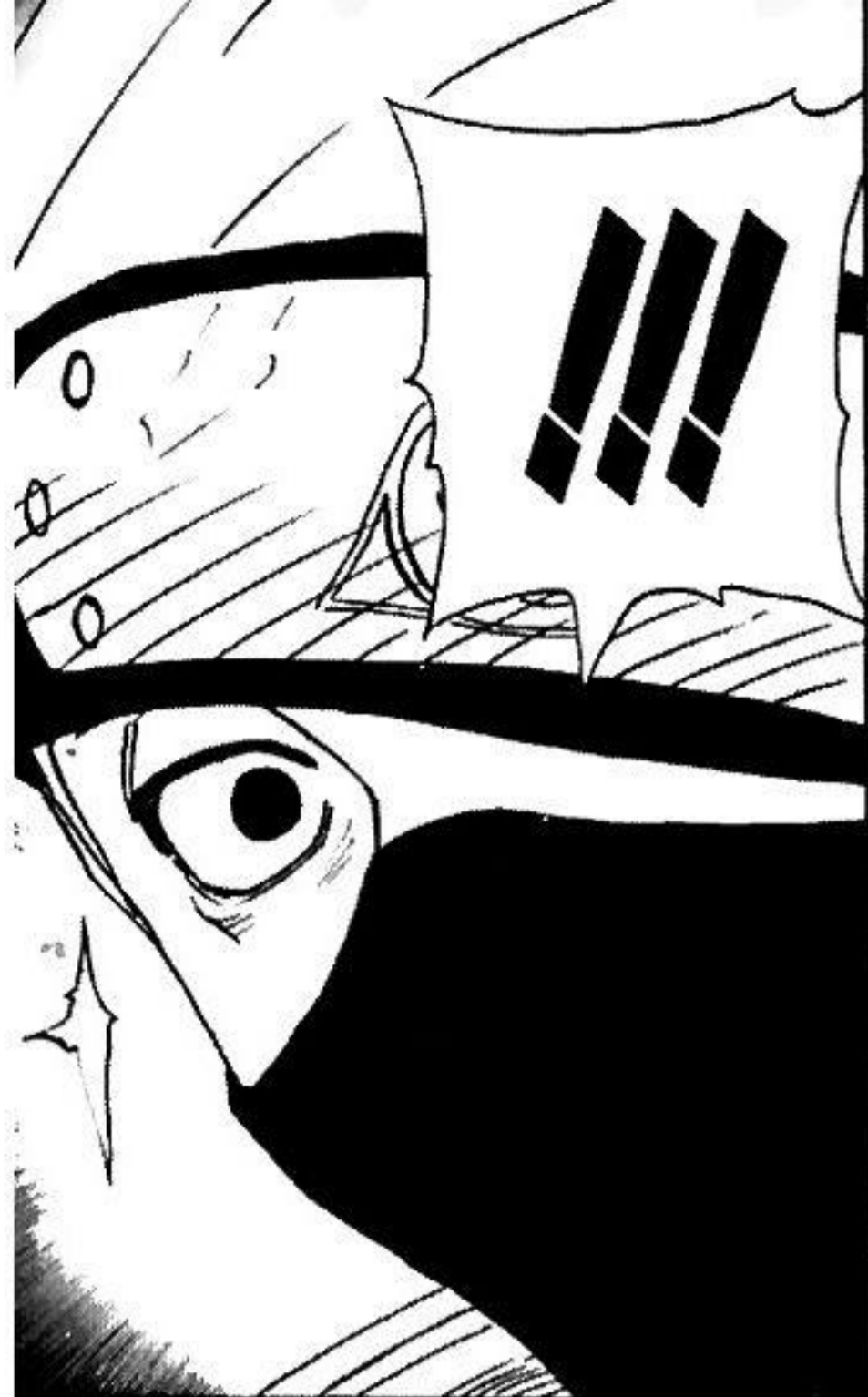

GUY ...
HIỆN TẠI THẲNG
BÉ CÓ THỂ MỞ
ĐƯỢC BAO NHIÊU
CỔNG "BÁT MÔN
ĐỘN GIÁP" ...!?

THẲNG BÉ PHỤC
HỒI THỂ LỰC
NHANH NHƯ THẾ LÀ
DO NÓ ĐÃ MỞ
ĐƯỢC "HUU MÔN"
RỒI SAO ...



NGŨ MÔN
(5 CỔNG)



NÀY GIỜ
HAI THẦY
NÓI GÌ
VẬY ?

GÌ MÀ
"BÁT
MÔN ĐỘN
GIÁP" ...
TỨC LÀ
SAO !?



THẲNG BÉ
NÀY ...
QUẢ NHIÊN
LÀ THIÊN
TÀI ...

CÓ CỐ
MẤY CŨNG
KHÓ MÀ
LÀM ĐƯỢC
NHƯ THẾ
...



!?



THÁO BỎ
GIỚI HẠN
?

ĐANG NÓI VỀ
"THÁO BỎ GIỚI
HẠN", BƯỚC
CHUẨN BỊ TRƯỚC
KHI THI TRIỂN
"LÝ LIÊN HOA"



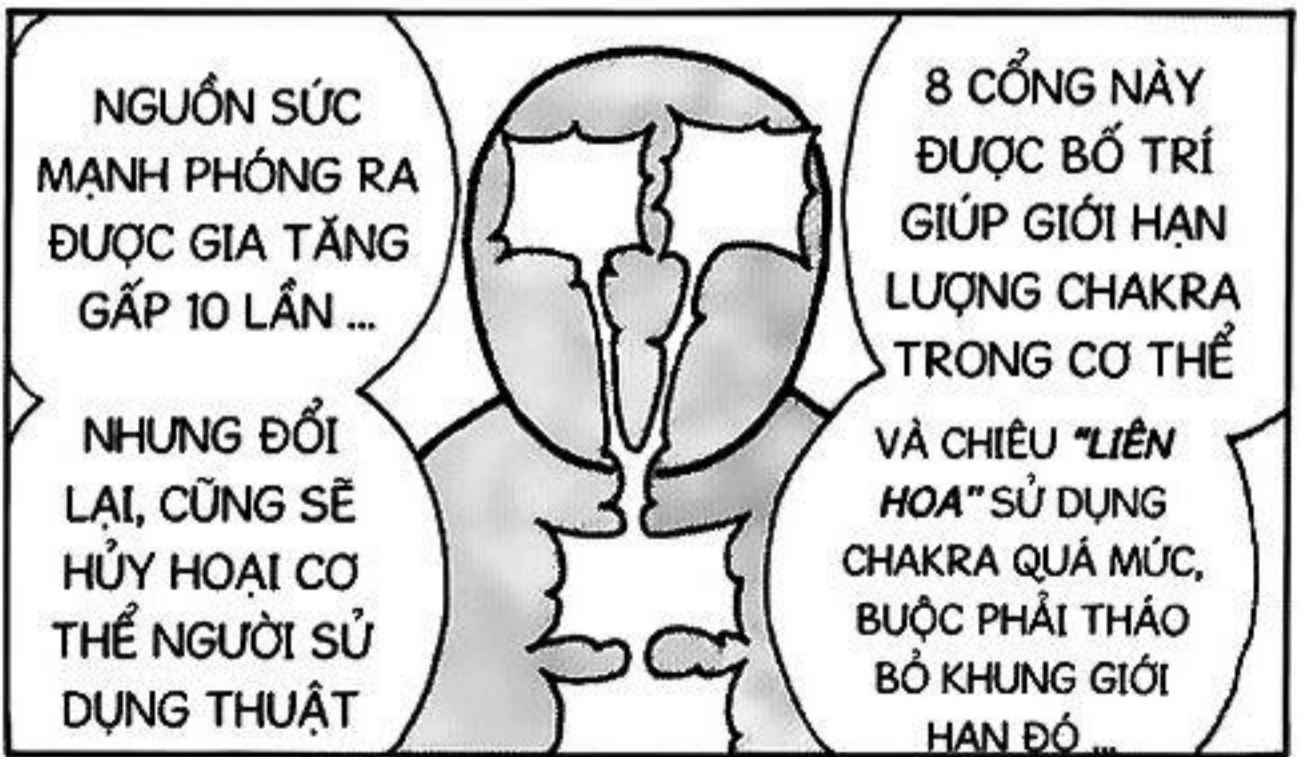
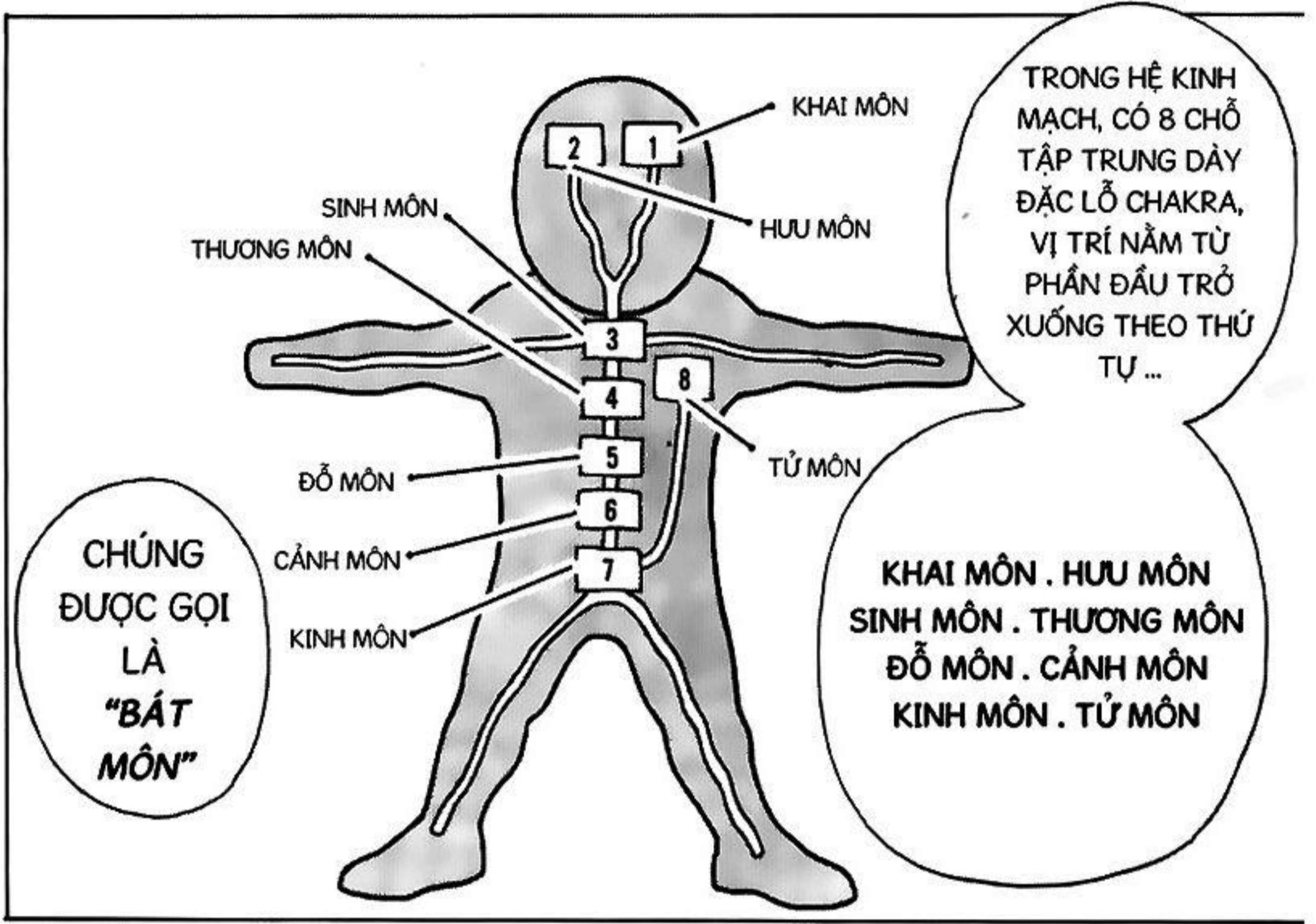
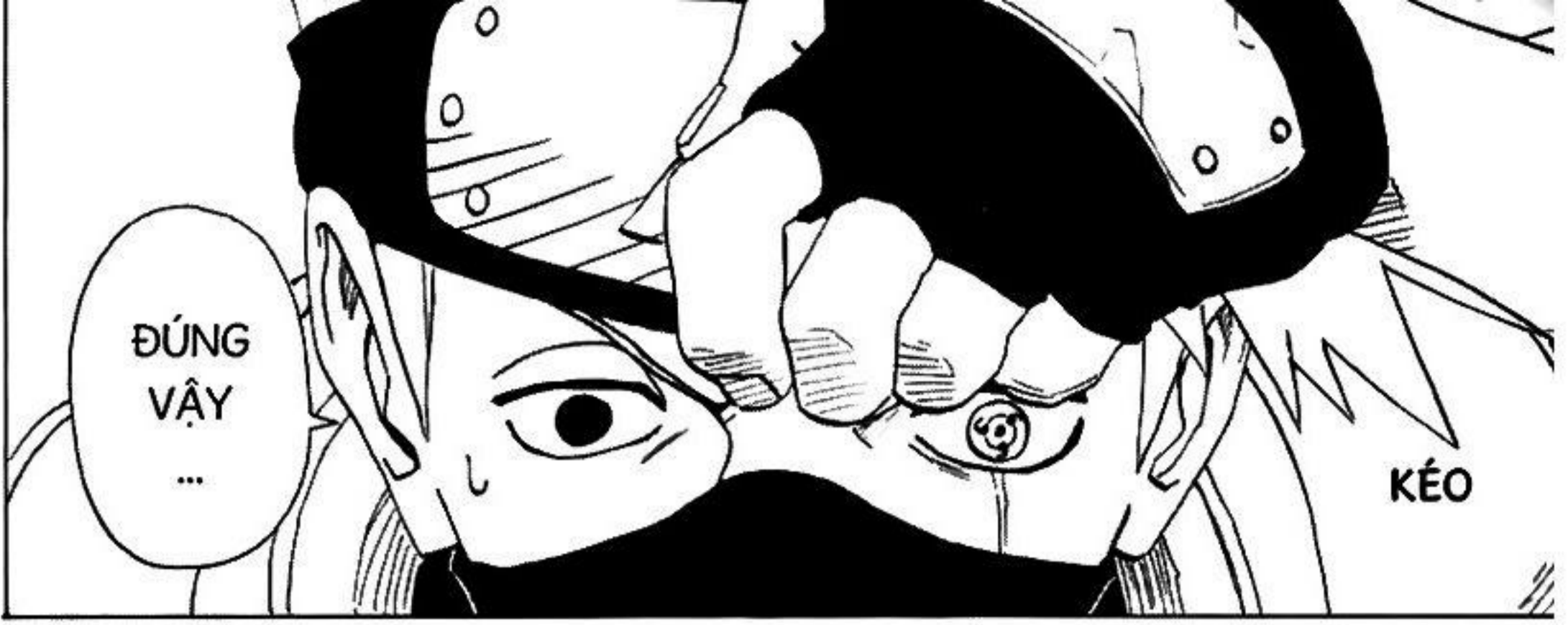



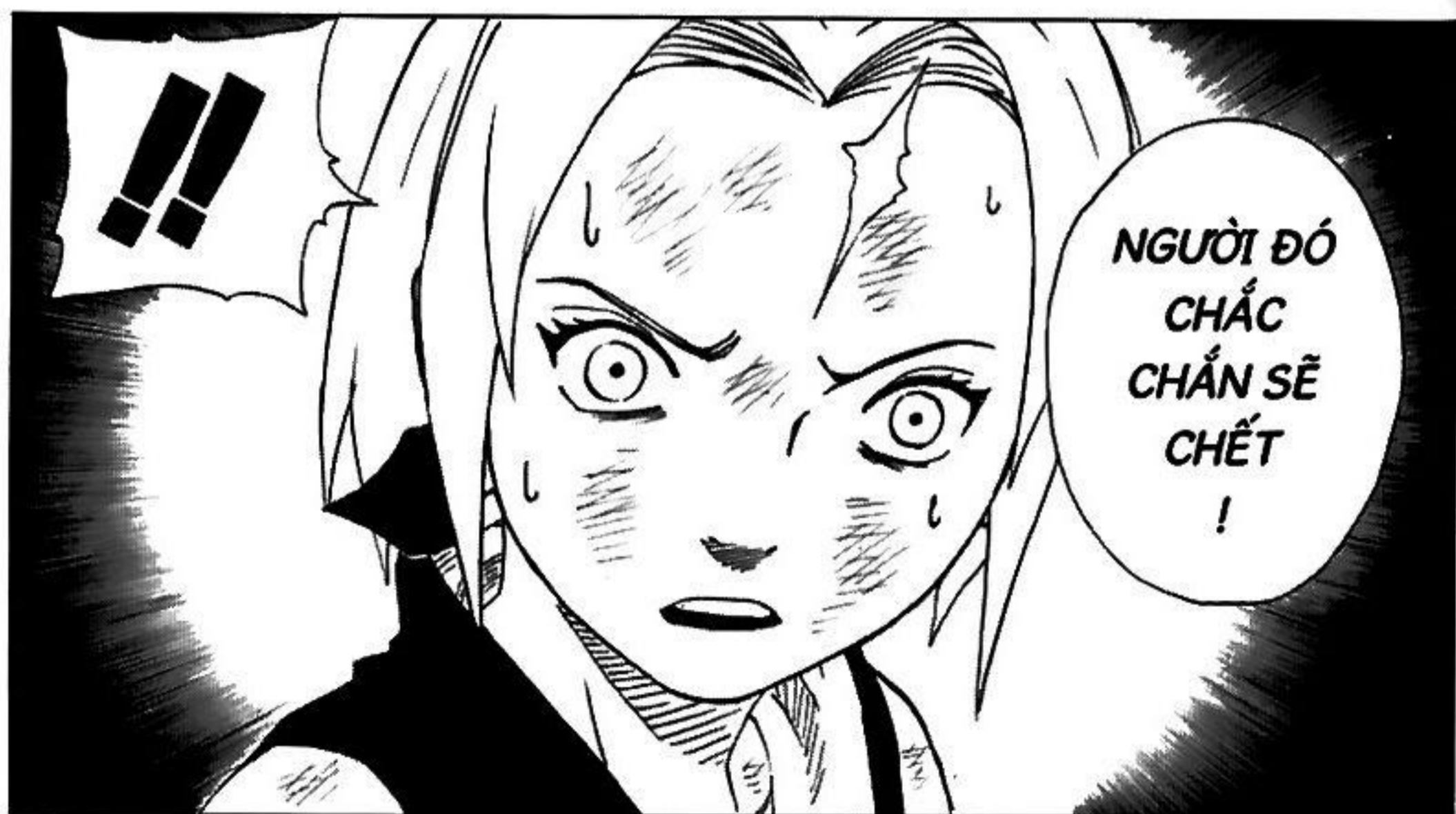









**NHÂN
ĐẠO
CỦA
MÌNH
!!**

**EM
CHỨNG
MINH
VÀ
BẢO
VỆ**

*ẦMM

**CỔNG 3
SINH MÔN
...
KHAI
!!**



**BẮT
ĐẦU
DI
CHUYỂN
!**

**ĐÃ MỞ
CỔNG 3
SINH
MÔN
RỒI...**



!!



!!

**MAU
ĐỎ
...!?**



!!

**CÓ THỂ
CHUYỂN
SANG...**

















VỤT

H

BA

BA





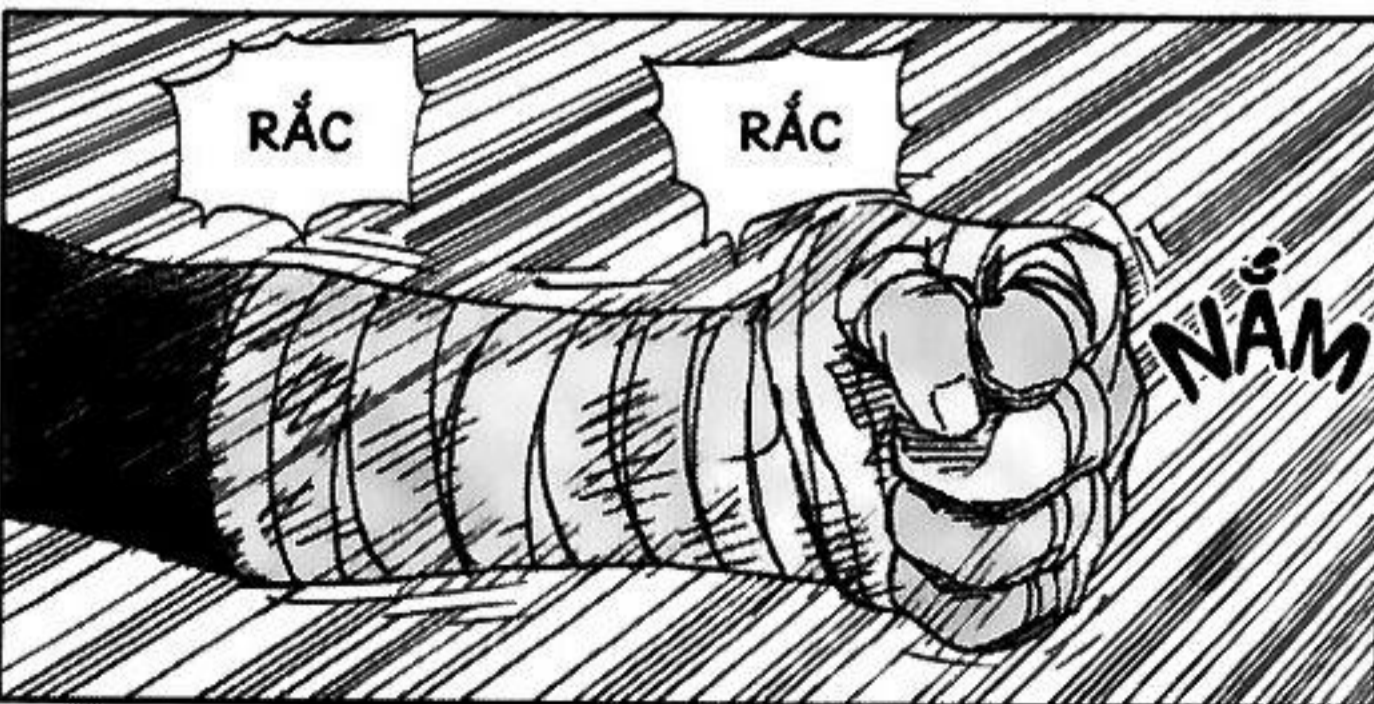
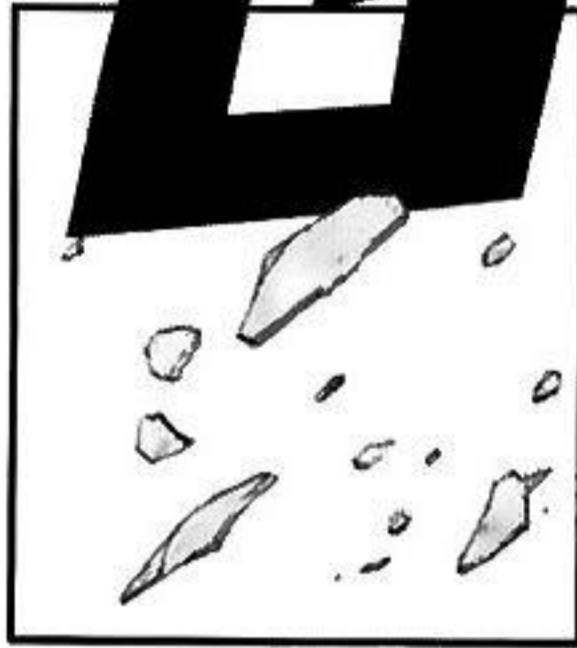







[THẾ GIỚI CỦA MASASHI KISHIMOTO]

TIỂU SỬ THỜI XA XUA 12

THỜI TRUNG HỌC TÔI CHỈ TOÀN CHƠI BÓNG CHÀY, HẦU NHU KHÔNG VẼ TRANH.

CUỐI TUẦN CHÚNG TÔI ĐỀU TẬP TỪ SÁNG SỚM ĐỂ CHUẨN BỊ CHO THI ĐẤU, CÒN PHẢI ĐI TẬP HUẤN NỮA. SO VỚI THỜI TIỂU HỌC THÌ CÀNG BẬN HƠN, KHÔNG CÓ THỜI GIAN RẢNH ĐỂ MÀ VẼ TRANH.

TÔI NGHĨ RẰNG: "CHẮC KHÔNG CÒN NHỮNG NGÀY THÁNG MÌNH CHỈ BIẾT CẠM CỤI VẼ TRANH NỮA RỒI", CHO ĐẾN MỘT NGÀY NỌ CÓ MỘT BƯỚC CHUYỂN KHÔNG NGỜ XẢY ĐẾN VỚI TÔI. CHO ĐẾN GIỜ TÔI VẪN KHÔNG THỂ QUÊN ĐƯỢC CÚ SỐC LÚC ĐÓ.

ĐÓ CHÍNH LÀ LÚC TÔI THẤY TẤM POSTER CỦA MỘT BỘ PHIM. ĐÓ LÀ POSTER CỦA "AKIRA", PHIM CỦA NHÀ SẢN XUẤT OOTOMO KATSUHIRO, TÔI THẤY ĐƯỢC TRÊN ĐƯỜNG ĐI VỀ NHÀ SAU KHI LUYỆN TẬP XONG.

LÚC NHÌN TẤM POSTER ĐÓ, NÓI THẬT TÔI THẤY SỐC KHÔNG THỂ TẢ, KHÔNG HIỂU SAO TÔI ĐÚNG LIỀN 1 TIẾNG ĐỒNG HỒ ĐỂ NHÌN TẤM POSTER ĐÓ. TRONG HÌNH LÀ CẢNH KANEDA ĐANG ĐI VỀ HƯỚNG CHIẾC MÔ TÔ, GÓC CHỤP LÀ TỪ TRÊN XUỐNG, PHẢI NÓI LÀ MỘT BỐ CỤC CỰC KÌ KHÓ. TÔI NGHĨ : "NGƯỜI NÀY, SAO MÀ CÓ THỂ VẼ ĐƯỢC MỘT BỐ CỤC KHÓ NHƯ THẾ NHỈ", "MÌNH CHƯA THẤY CÓ NGƯỜI NÀO VẼ ĐƯỢC BỐ CỤC KHÓ THẾ NÀY ..."

LÚC ĐÓ TÔI CẢM NHẬN ĐƯỢC NHÂN VẬT VÀ CẢ CHIẾC MÔ TÔ RẤT THẬT, PHỐI CẢNH TUYỆT TỐI NỔI HÌNH DUNG ĐƯỢC NHÂN VẬT ĐANG ĐỨNG TRÊN MẶT ĐẤT THẾ NÀO NỮA, NÓI CHUNG LÀ CỰC KÌ SỐNG ĐỘNG. TRÊN CHIẾC MÔ TÔ CŨNG CÓ CẢ ĐƯỜNG NÉT CHI TIẾT, MẶT ĐÁ THÌ BỊ HỦY HOẠI, THẤY ĐƯỢC CẢ CÁC CỤC ĐÁ NHỎ. NÓI CHUNG LÀ CỰC KÌ CHI TIẾT. NHÌN BỨC TRANH PHÁ CÁCH KHÔNG THEO KHUÔN KHỔ TRUYỀN THỐNG ĐÓ THẬT SỰ ĐÃ LÀM BÙNG CHÁY NGỌN LỬA ĐAM MÊ VẼ TRONG TÂM TÔI. VÌ MUỐN VẼ ĐƯỢC NHƯ BỨC TRANH ĐÓ DÙ CHỈ MỘT CHÚT CŨNG ĐƯỢC NÊN NHỮNG BỨC TRANH TÔI VẼ CHO TỚI GIỜ THÀNH RA NHƯ THẾ ĐẤY.



NARUTO

NGUỒN : BLOGTRUYEN.COM

SCAN : NGANKVN
Edit : KYO

CÁC NƠI KHÁC VUI LÒNG :

- GHI RÕ NGUỒN : BLOGTRUYEN.COM
- POST SAU BLOGTRUYEN.COM 2 CHAP
- KHÔNG XÓA-SỬA CREDIT VÀ TRANG TRUYỆN

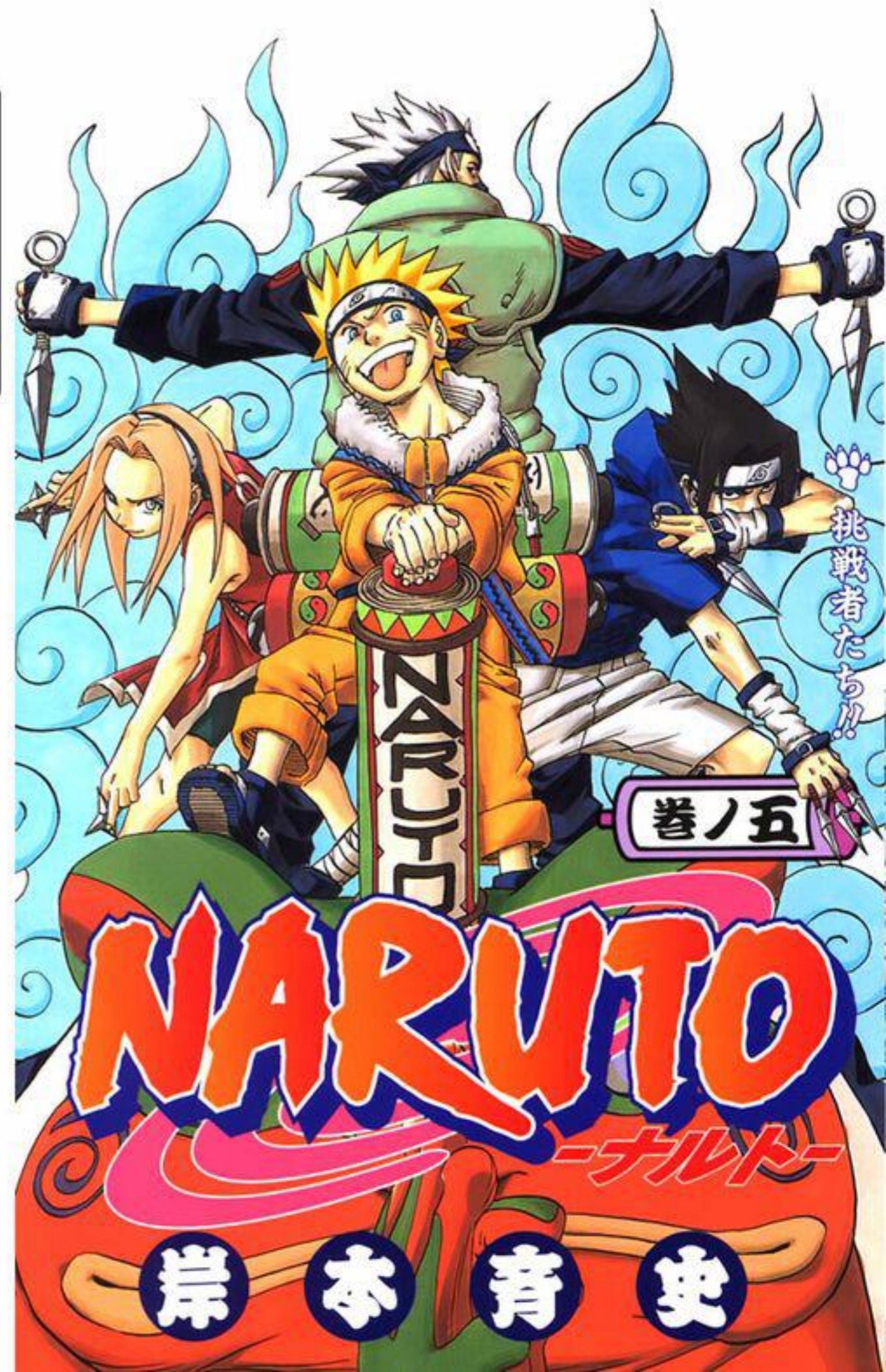



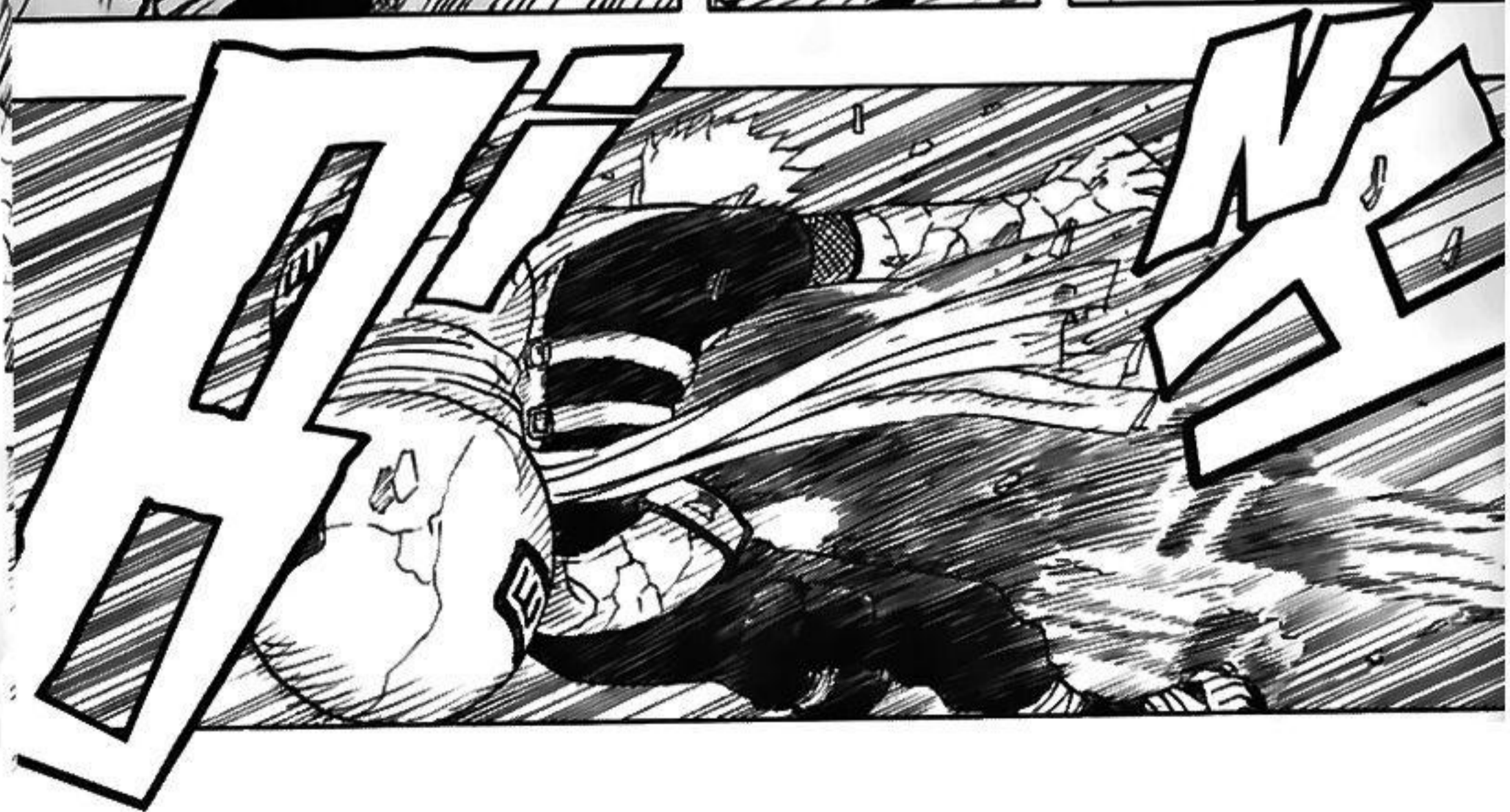



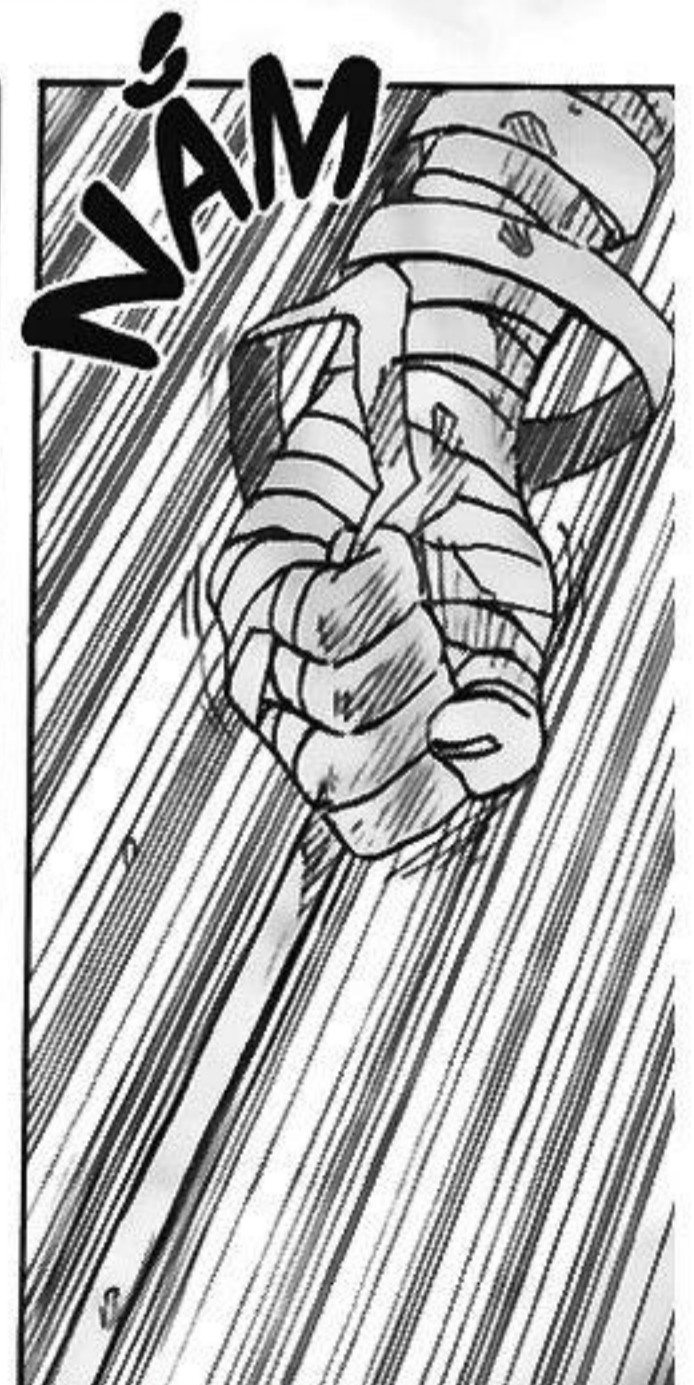
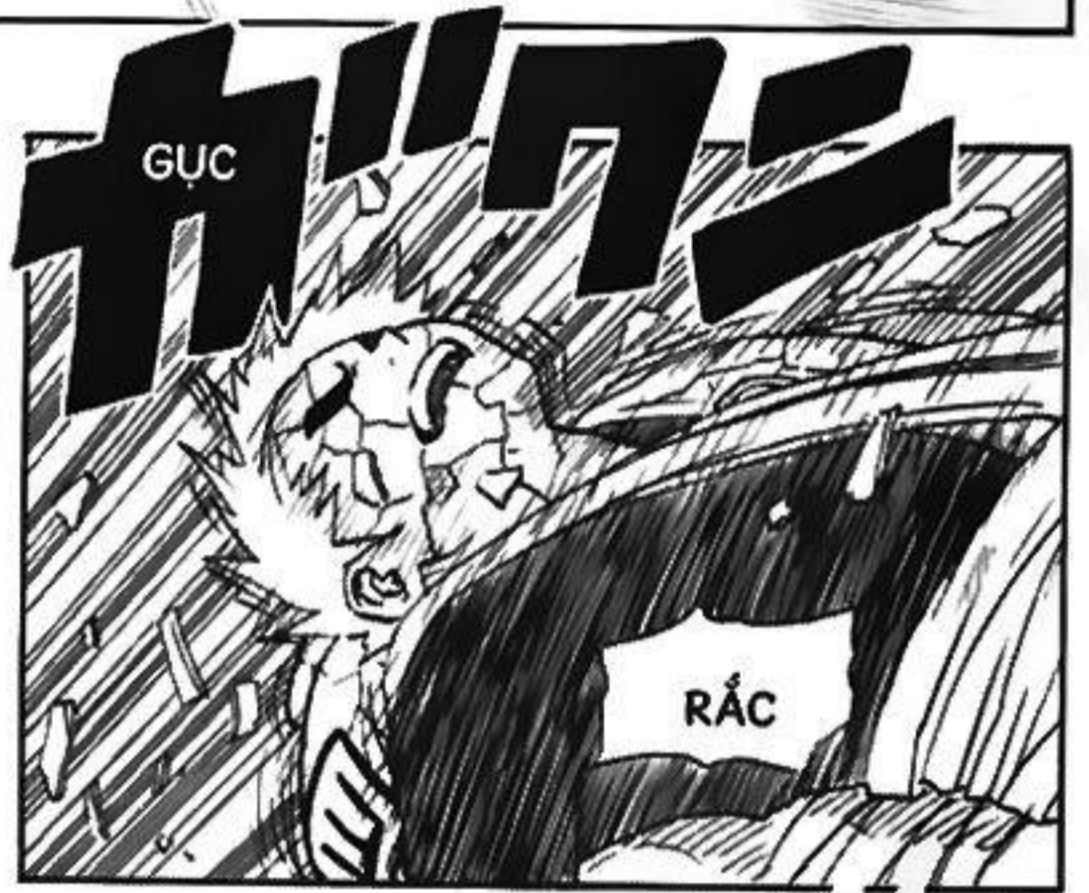
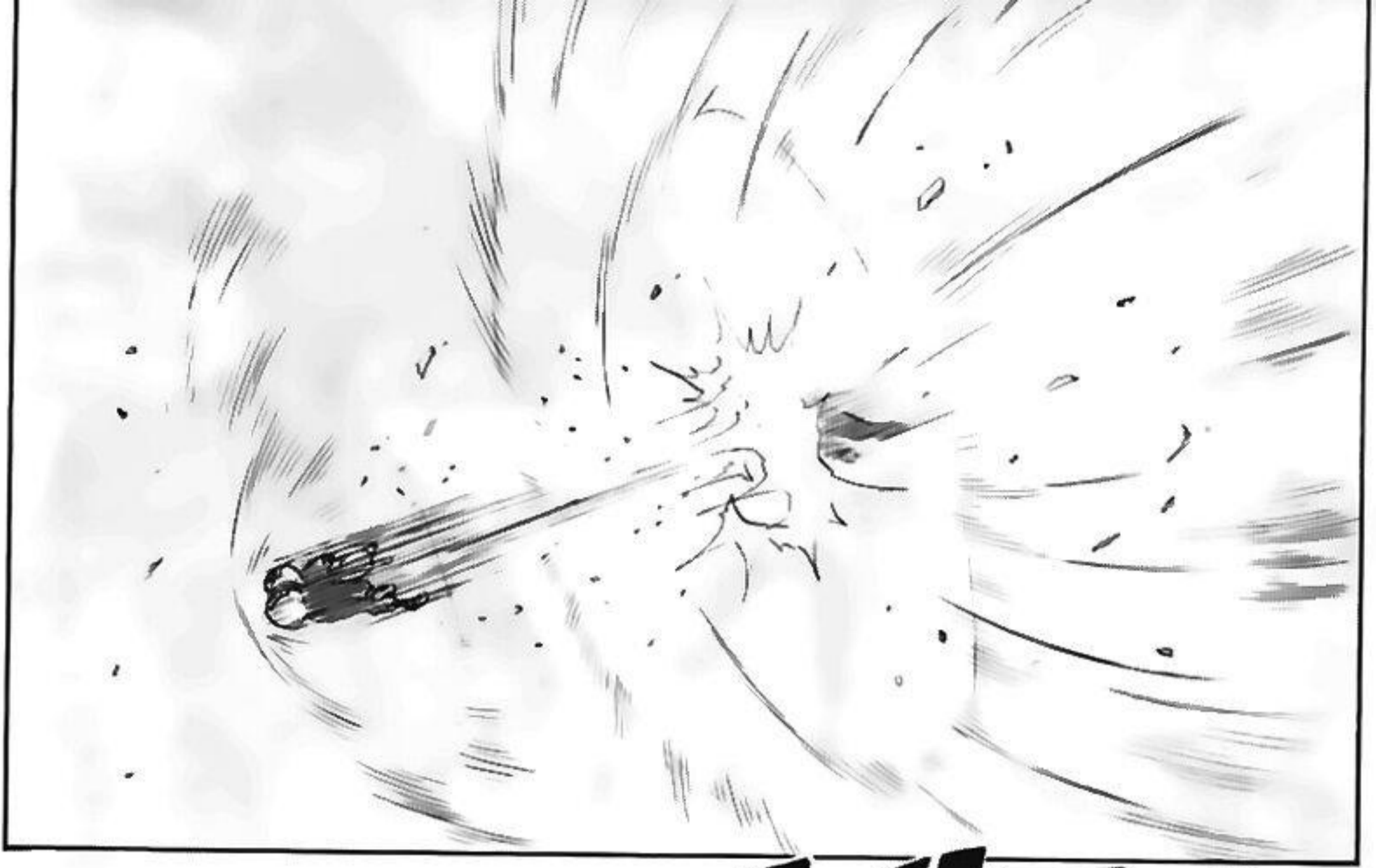





NÓ CHÍNH LÀ ĐÒN KẾT THÚC!

CÁCH HẠ NEJI CHÍNH LÀ CHIÊU COMBO TỐC ĐỘ CAO NÀY ...

ĐI NHIÊN ĐỒNG CẮT ĐÓ KHÔNG THỂ THEO KỊP ...!

LÝ LIÊN HOA ... CÓ THỂ NÓI LÀ THỂ THUẬT LIÊN CHIÊU TỐC ĐỘ CAO, KHÔNG THỂ CHẠM TRÚNG!!



ÁO GIÁP CẮT CŨNG BỊ VỠ

KHIÊN CẮT KHÔNG THỂ THEO KỊP

NGUY RỒI !!

KÉO



GIẬT

AAA
AAA
!!

!!

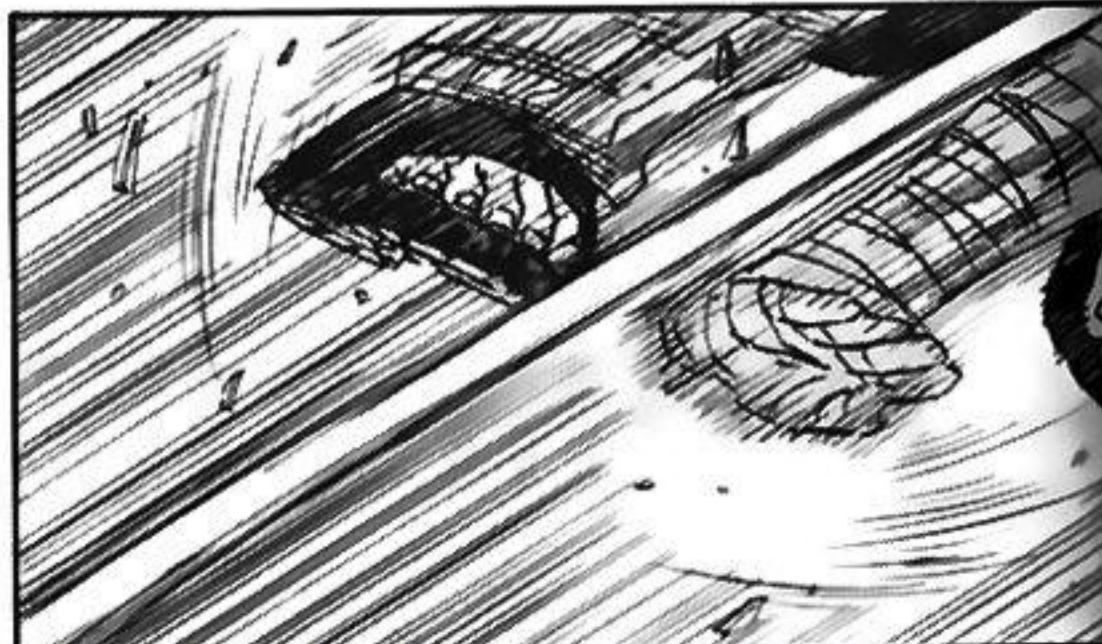



**LÝ
LIÊN
HOA
!!!**



NINJA KIẾT XUẤT ...!!



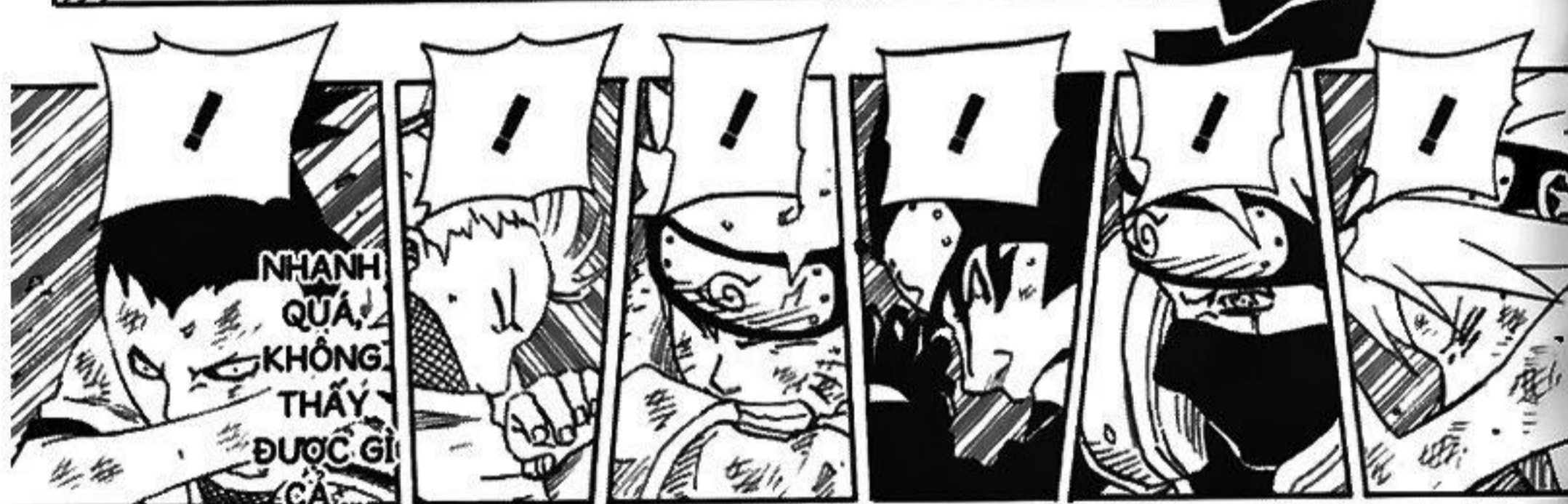
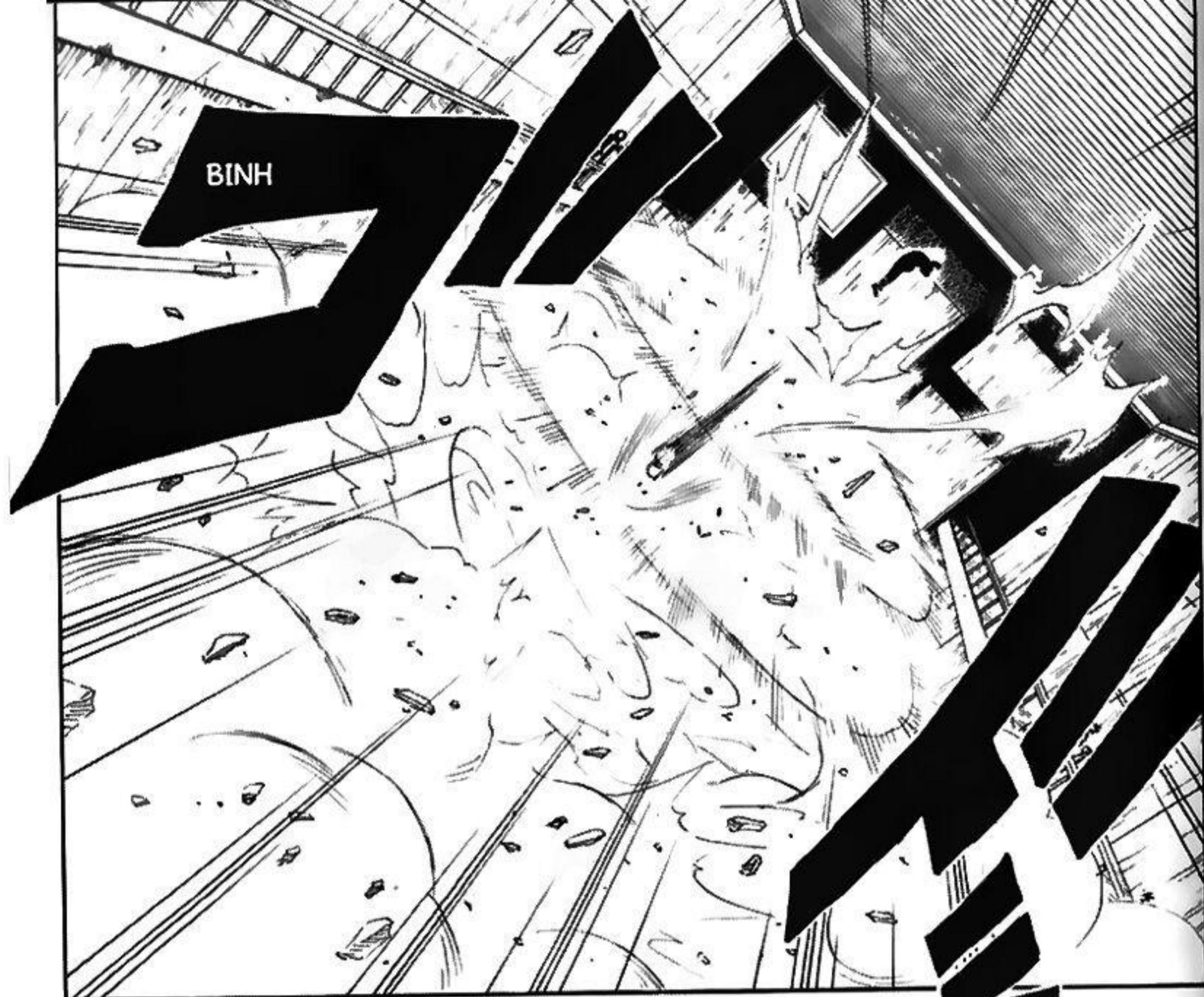



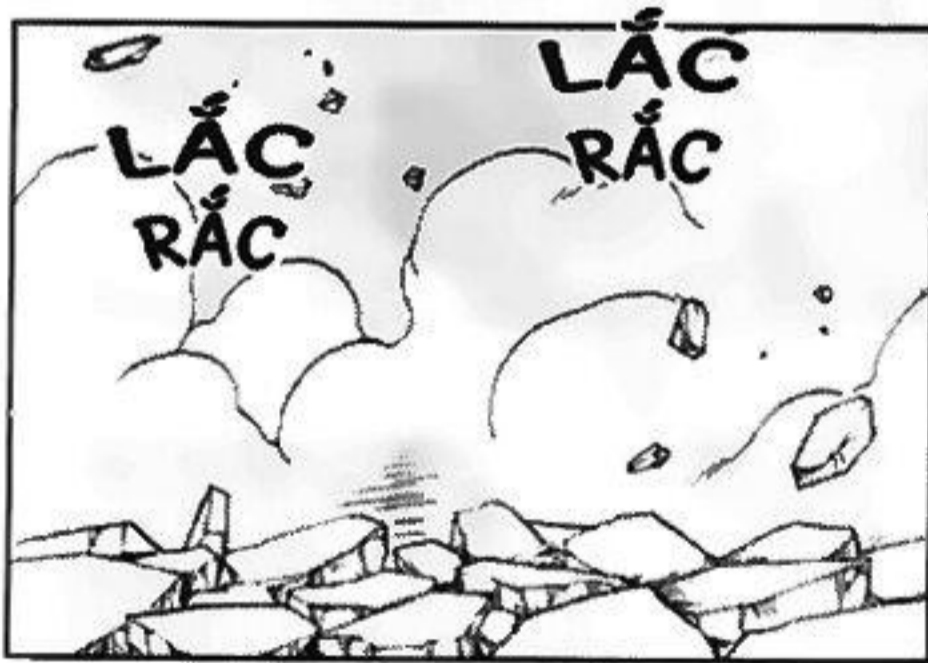



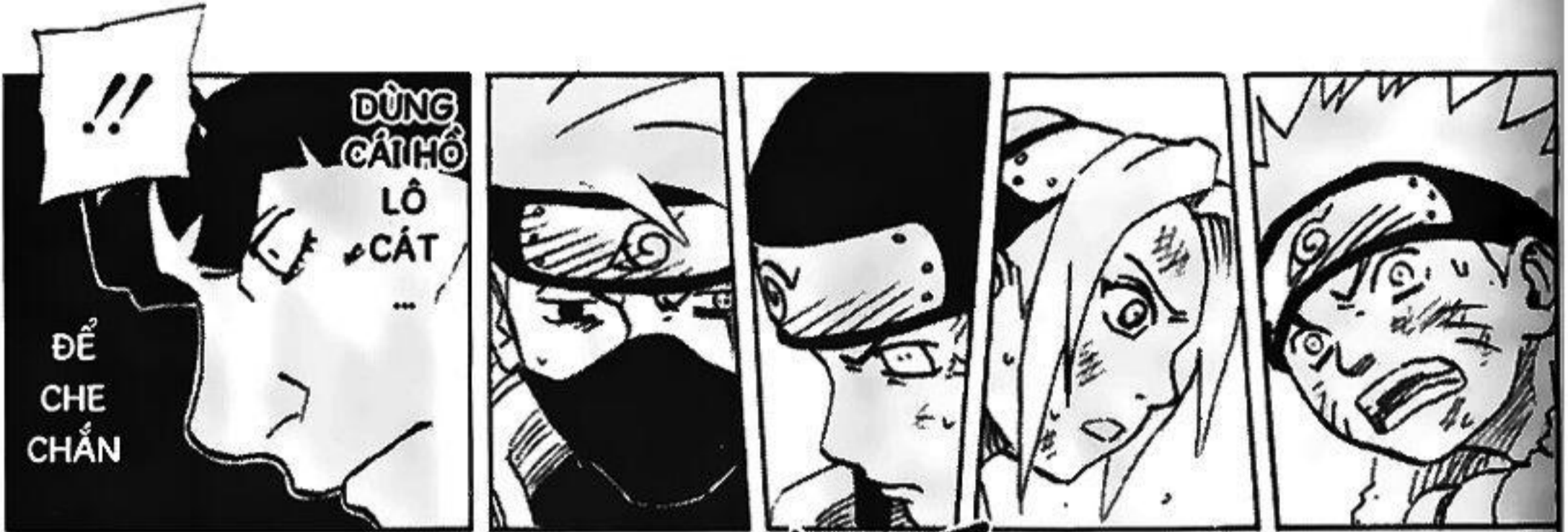



















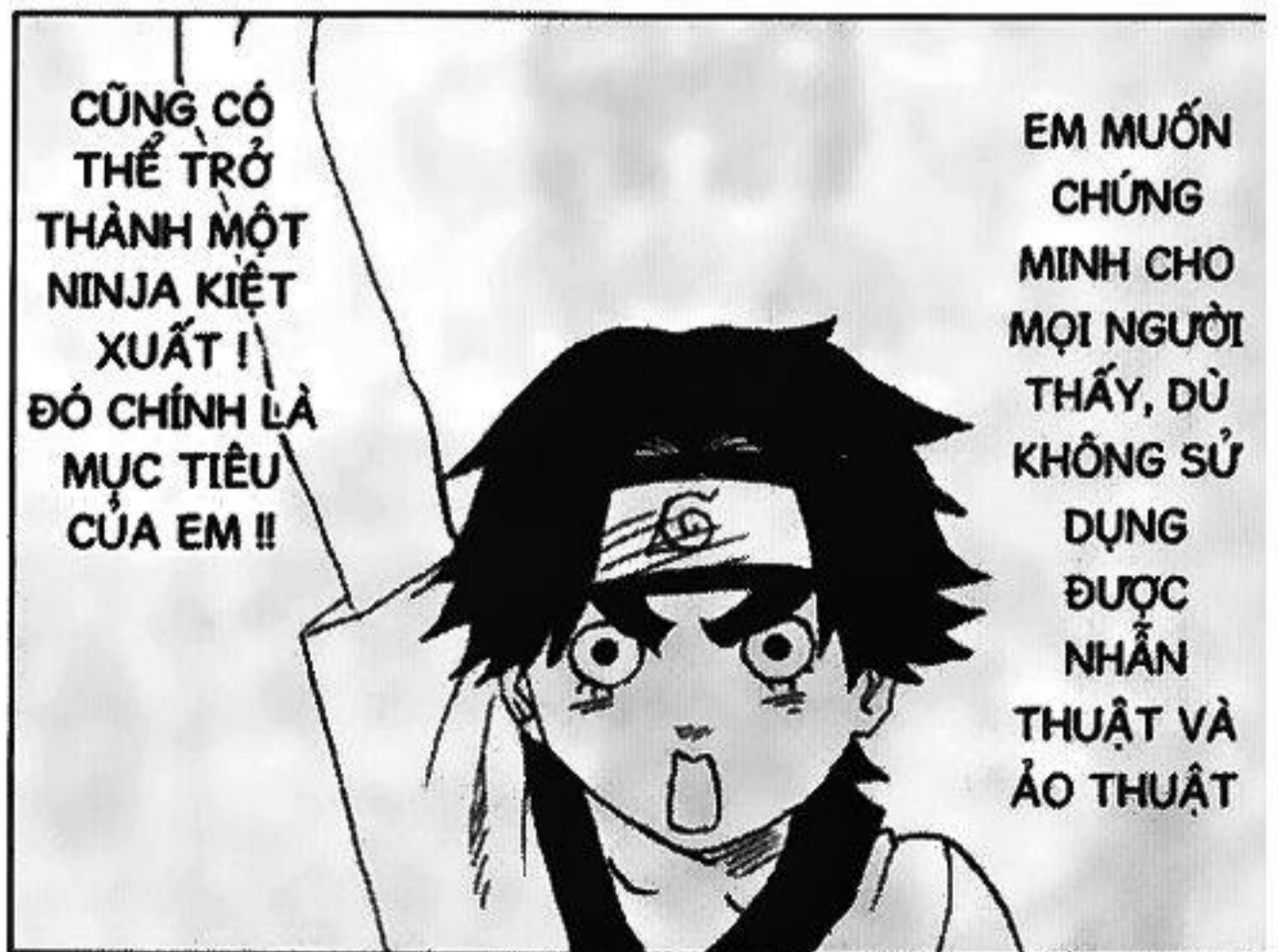
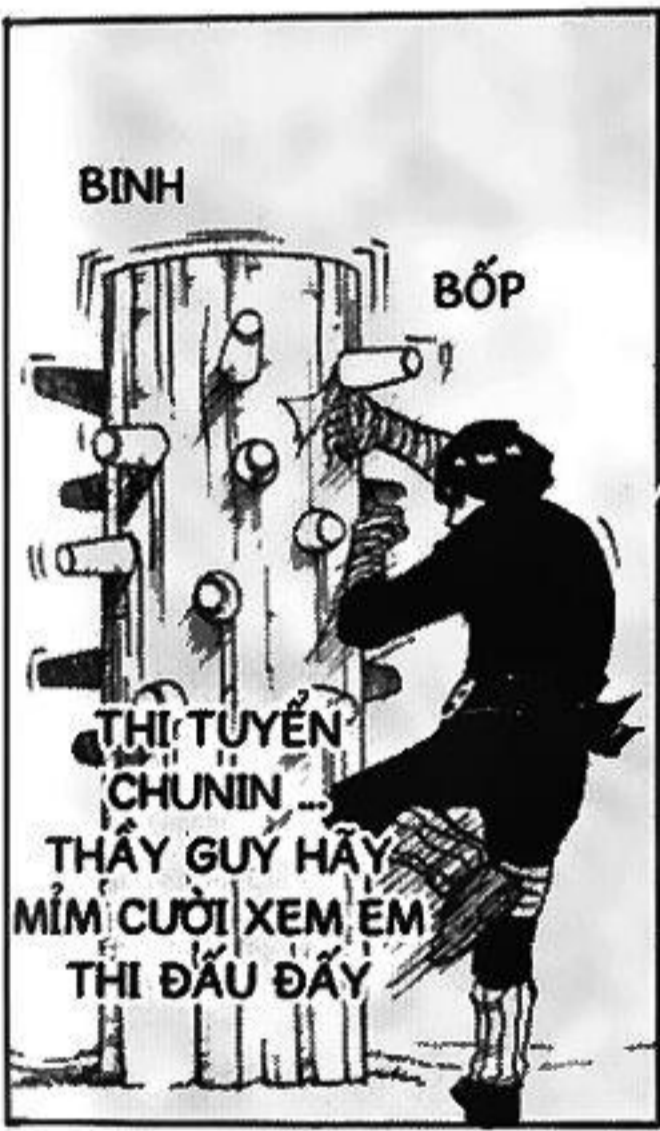





CHÍNH LÀ
"THUỘC HẠ"
QUAN
TRỌNG, YÊU
QUÍ NHẤT
CỦA TA



NHỮNG TỪ
NÀY, GAARA
KHÔNG THỂ
NÀO LÝ GIẢI
ĐƯỢC ĐÂU ...



QUAY

VÙ
VÙ

BỘP



NGƯỜI
THẮNG
GAARA
!

VÙ
VÙ



VÙ VÙ

VỤT

VẬY
THÔI
...



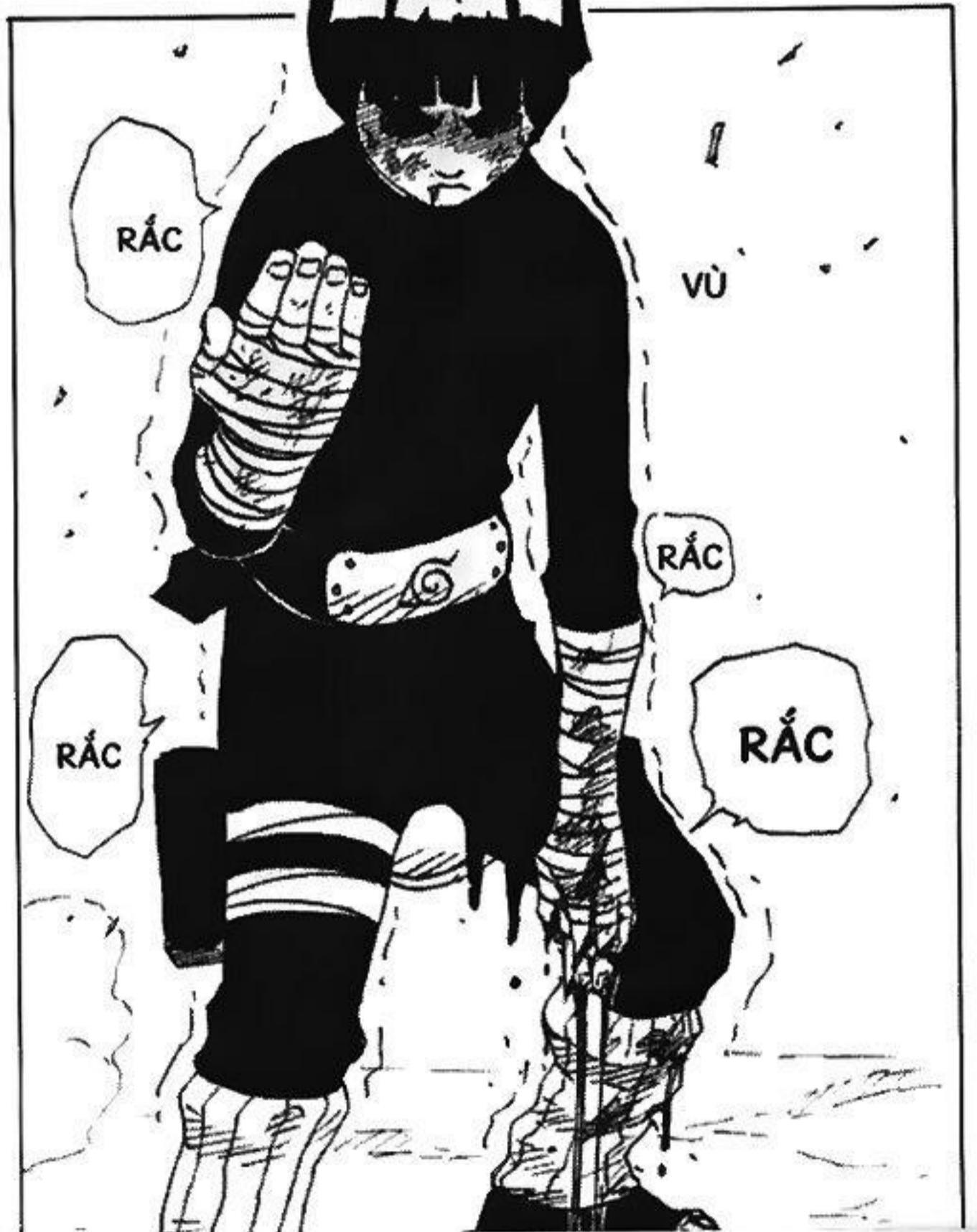
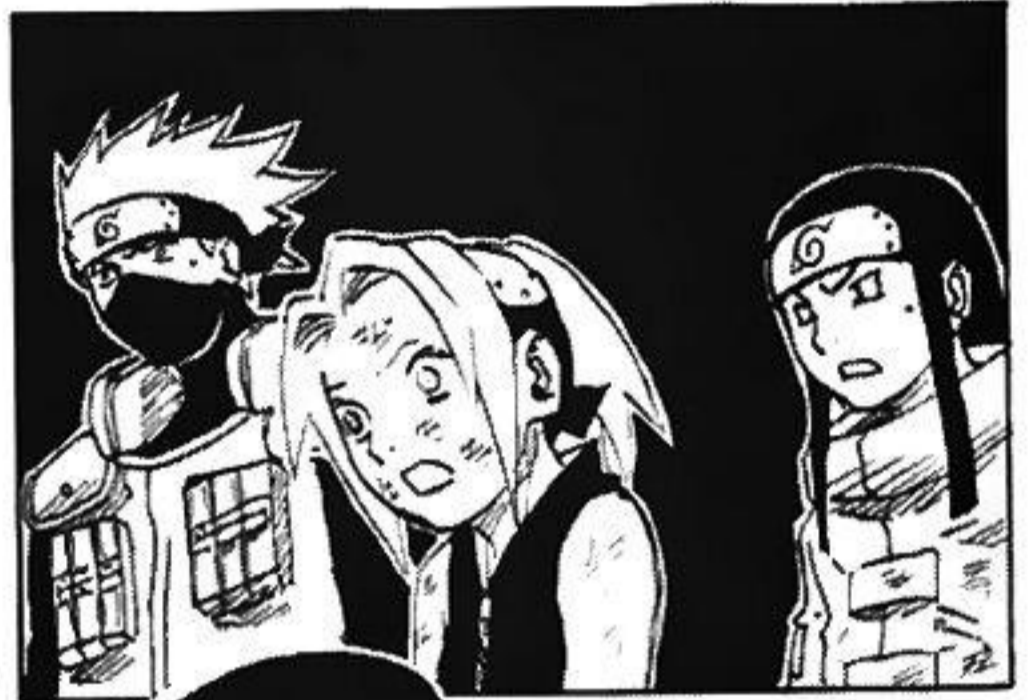









CHÚNG
MINH
NHẢY ĐẠO
CỦA MÌNH
...



NGAY CẢ KHI
MẤT ĐI Ý
THỨC MÀ
VẪN
...

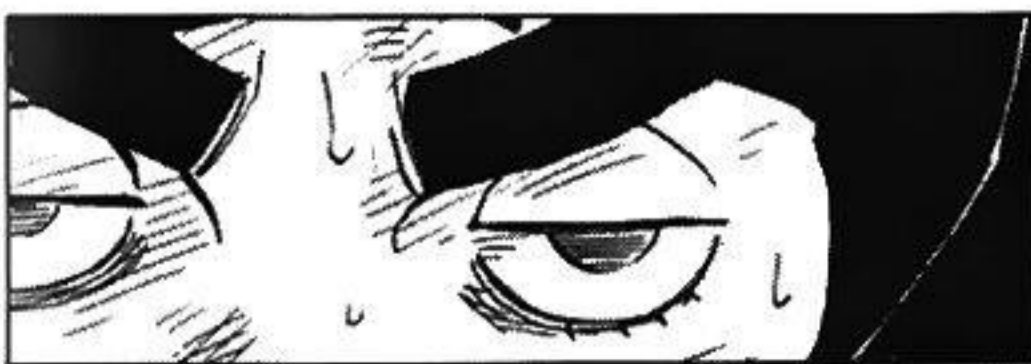

EM
ĐÚNG
LÀ
...



LEE
...



NINJA KIỆT XUẤT

...!

ÔM
CHẶT







●「NARUTO」

BLOGTRUYEN.COM



NARUTO

NGUỒN : BLOGTRUYEN.COM

SCAN : [NGANKVN](#)
Edit : [KYO](#)

CÁC NƠI KHÁC VUI LÒNG :

- GHI RÕ NGUỒN : BLOGTRUYEN.COM
- POST SAU BLOGTRUYEN.COM 2 CHAP
- KHÔNG XÓA-SỬA CREDIT VÀ TRANG TRUYỆN

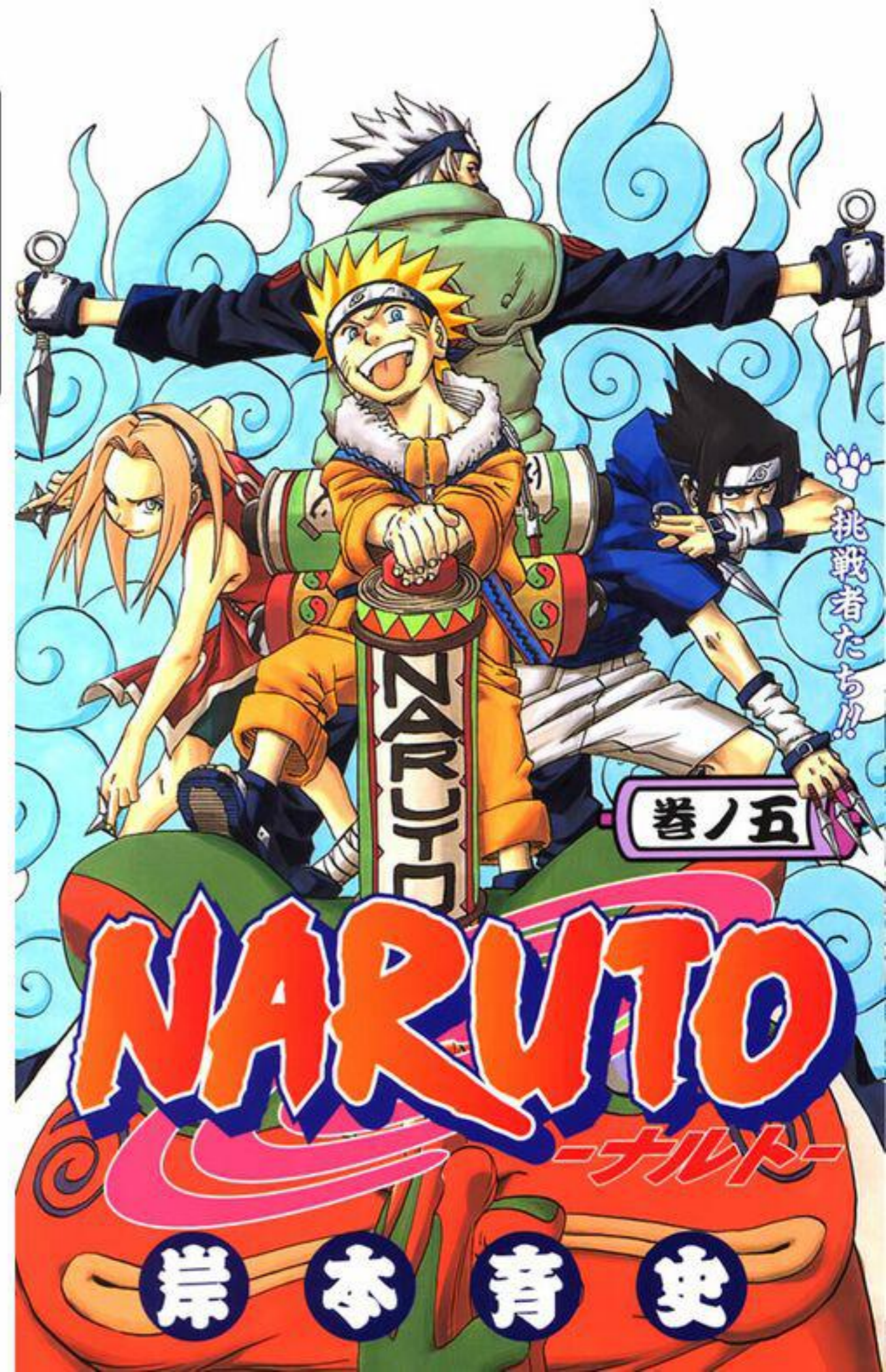



 **87 : KẾT THÚC
ĐẤU LOẠI ...!!**





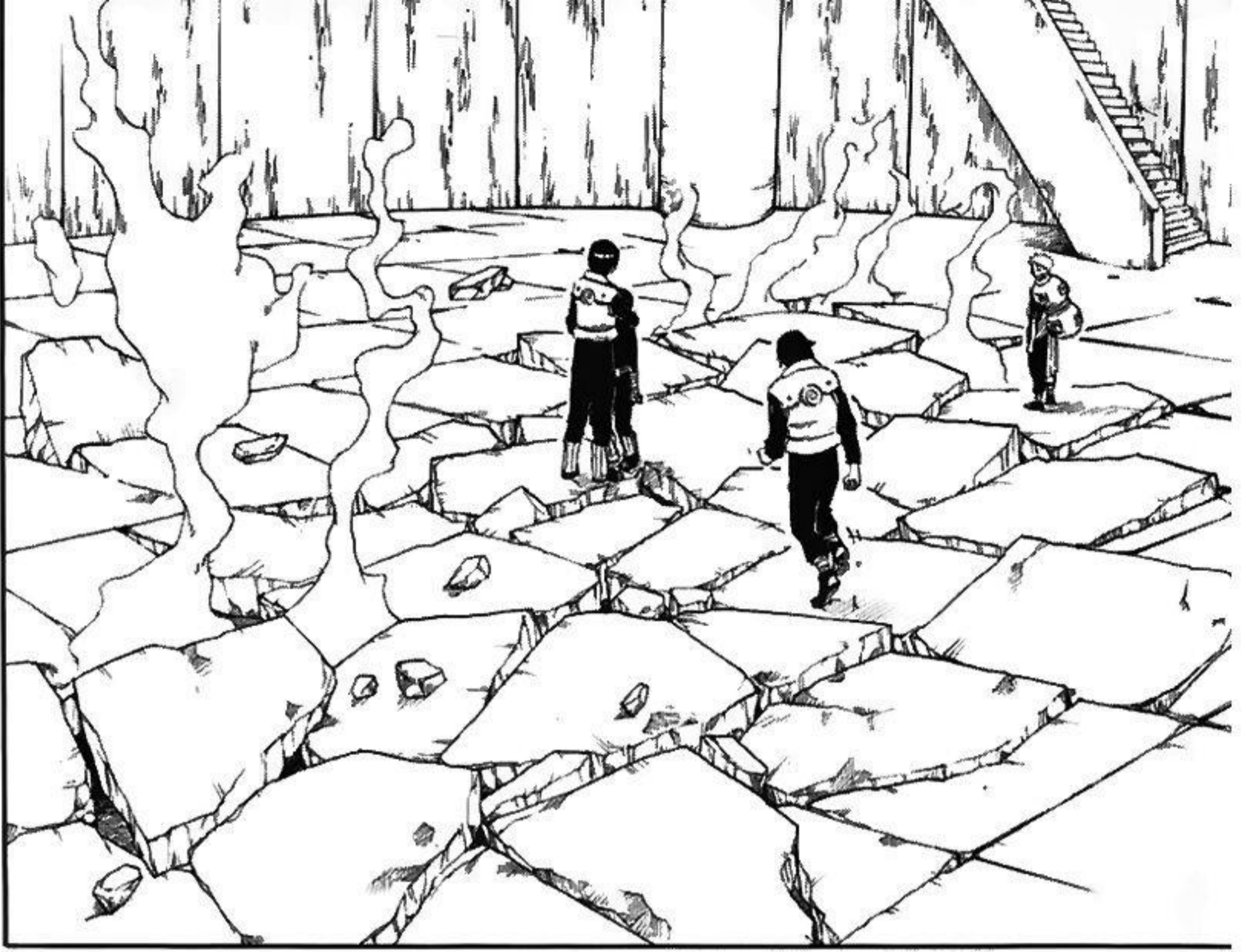







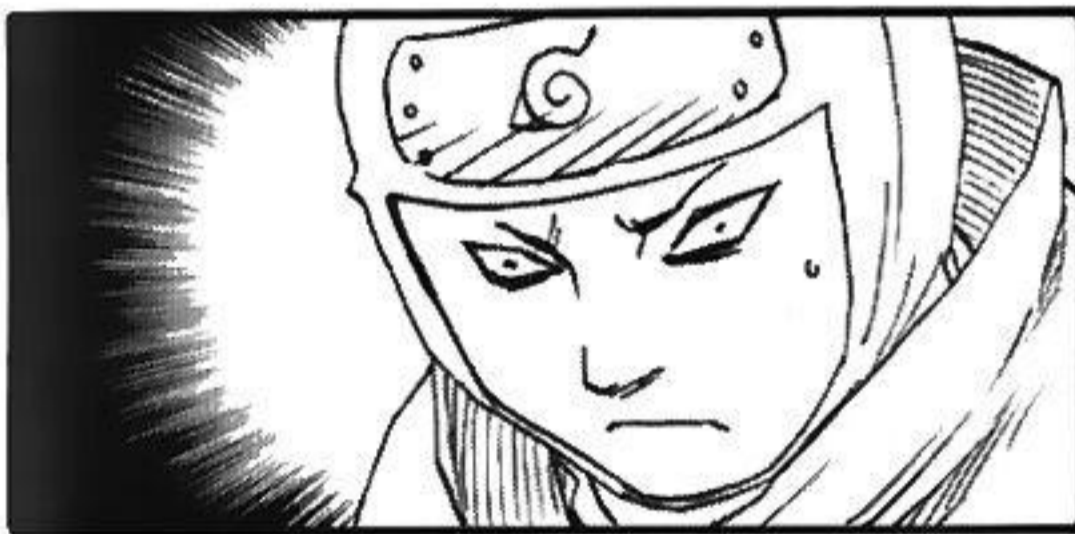



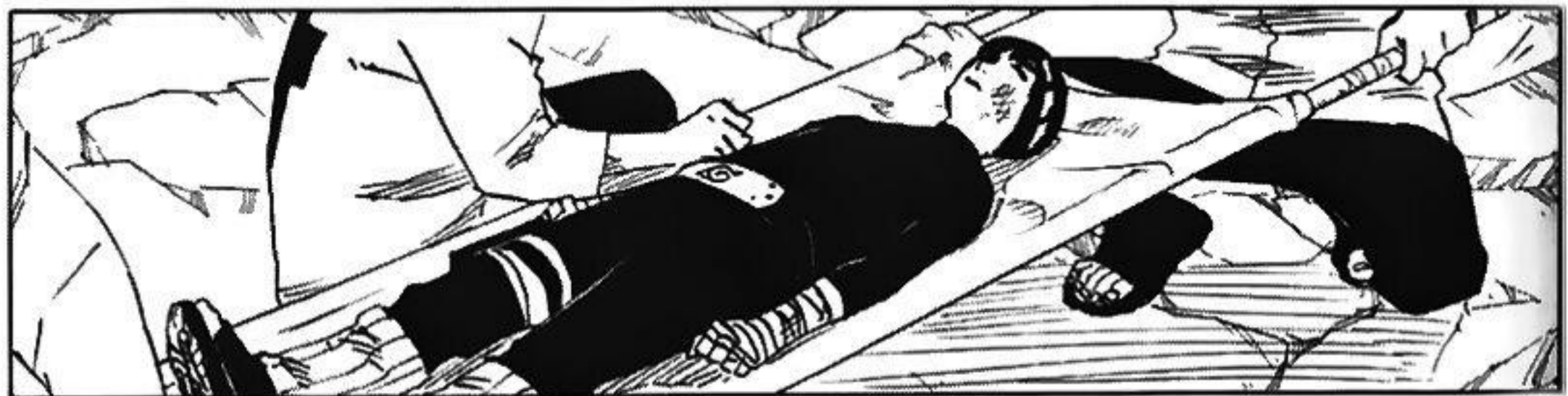



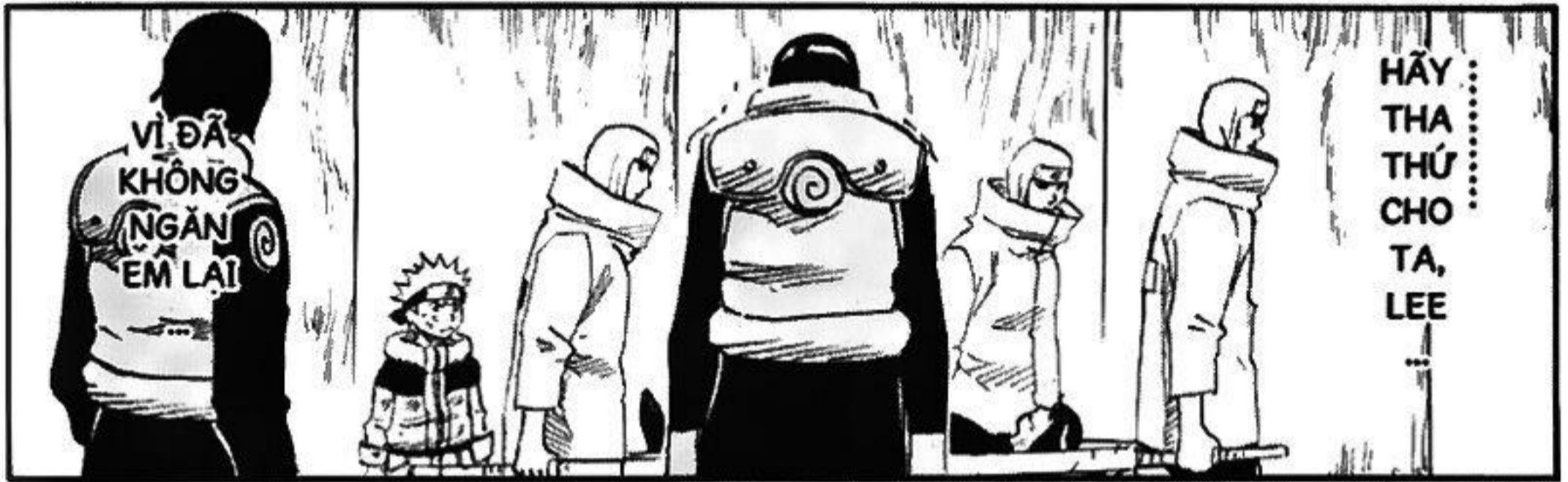











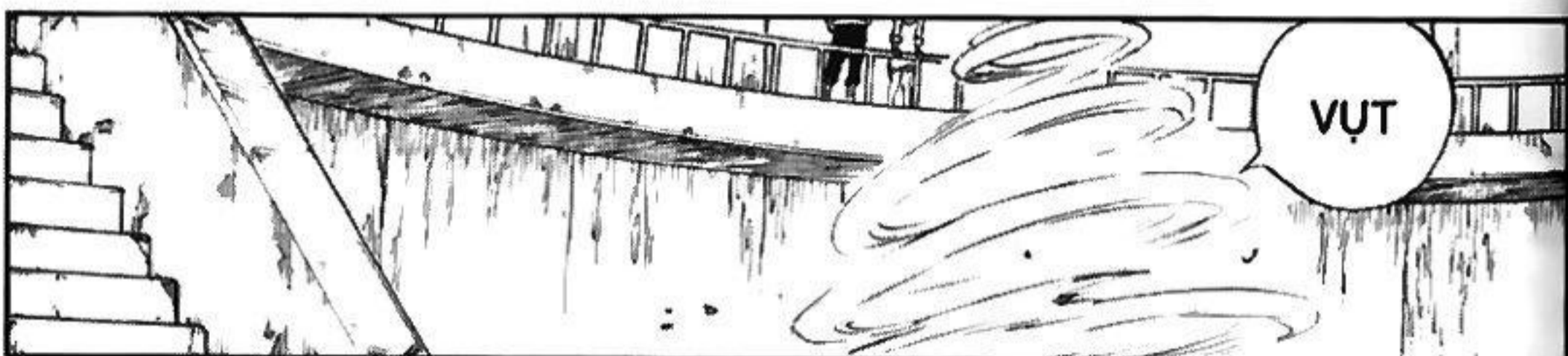
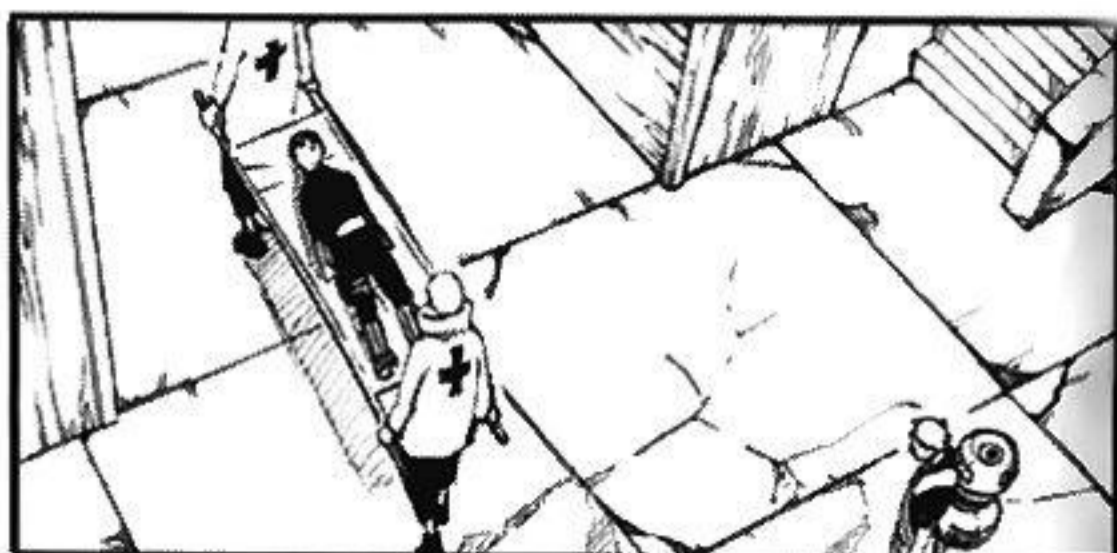



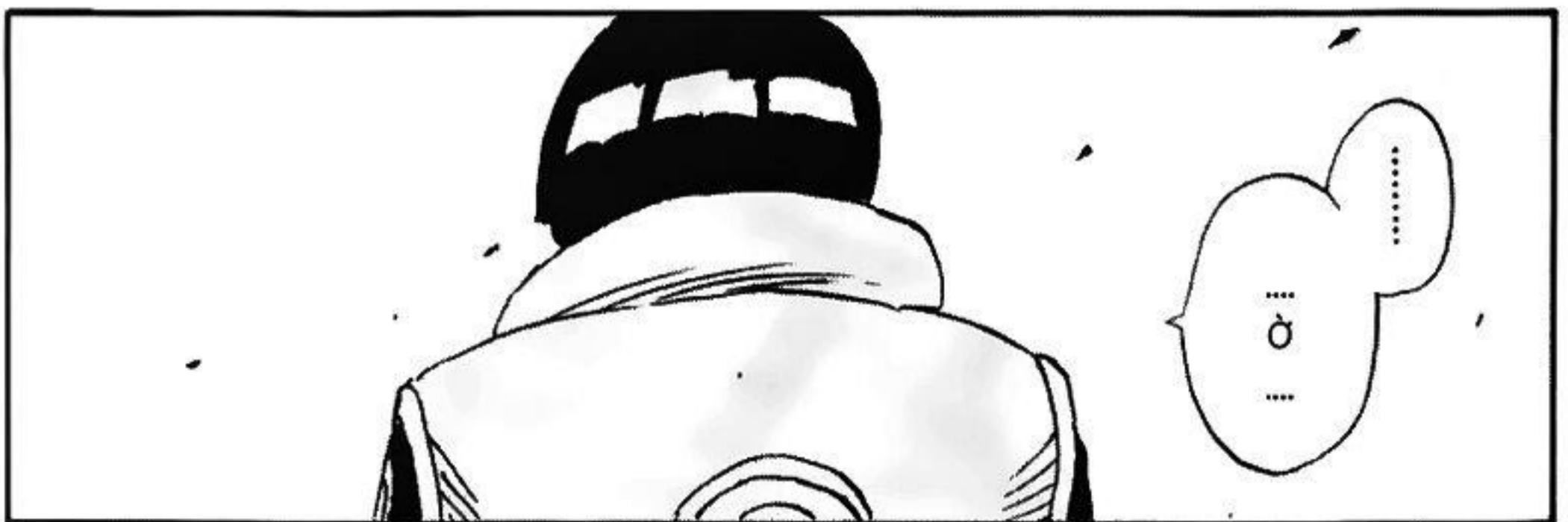



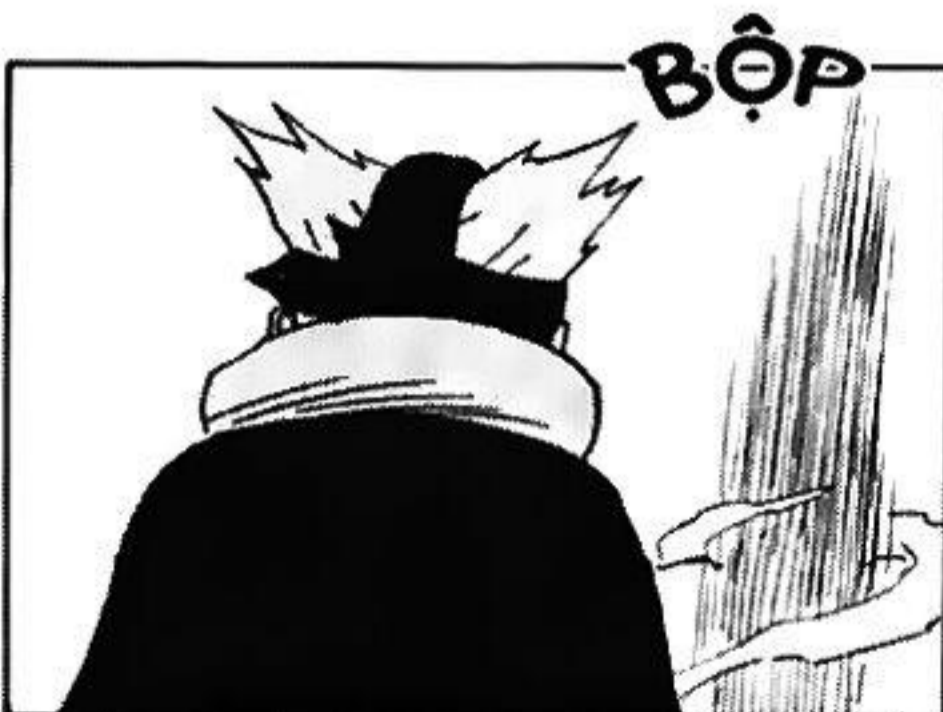
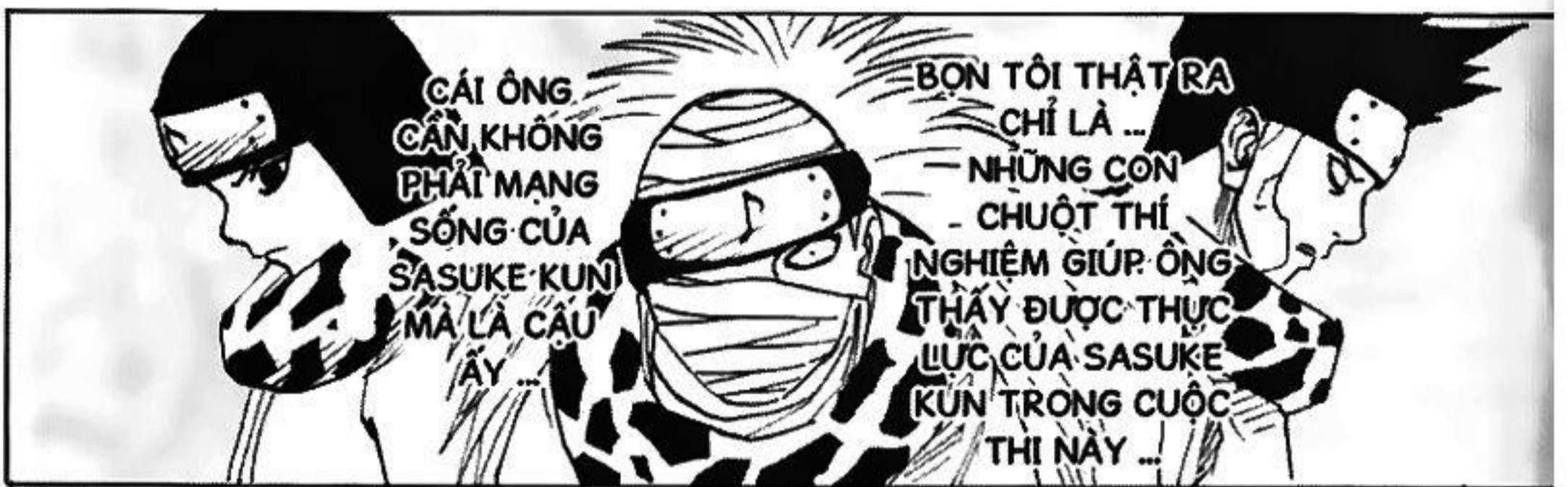
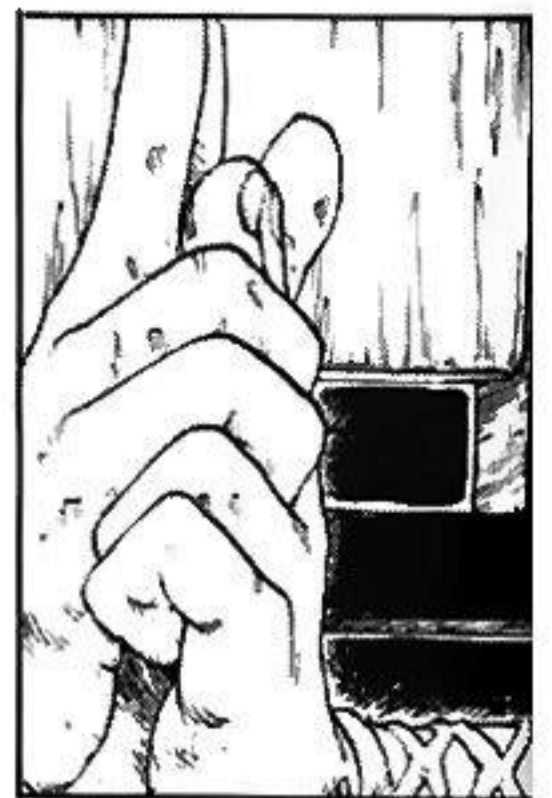















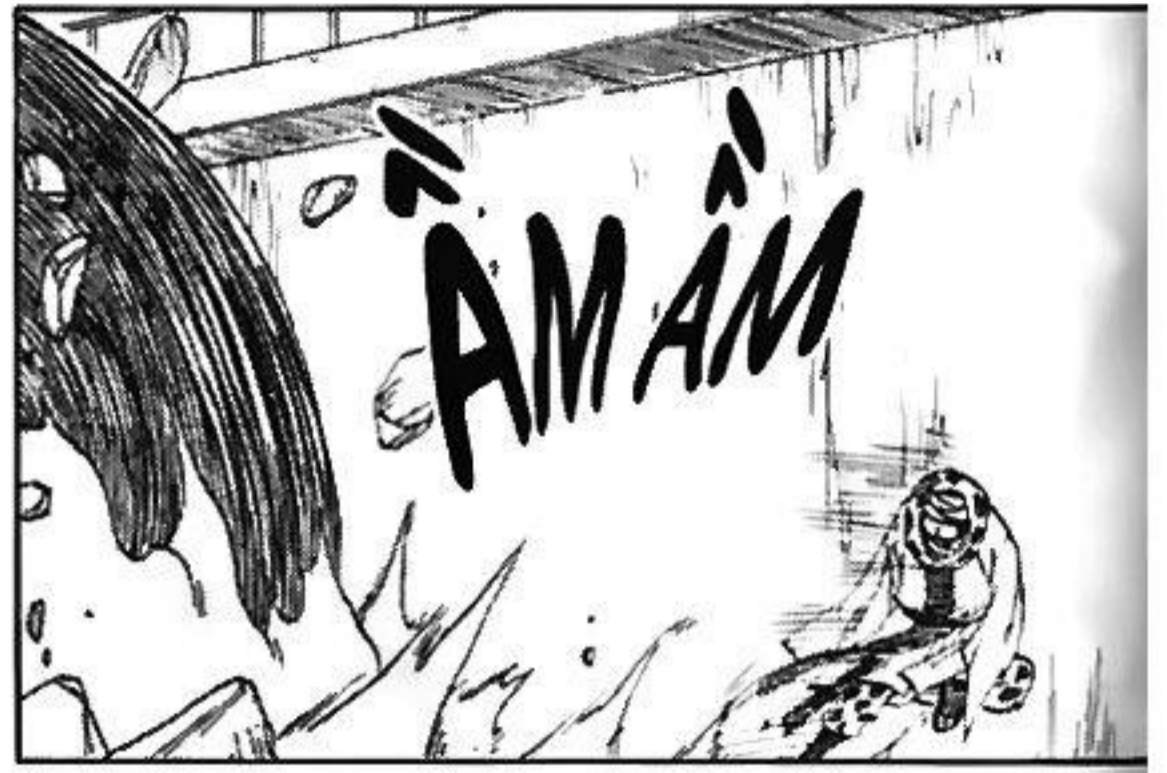





*TTTTTTTTTTTT





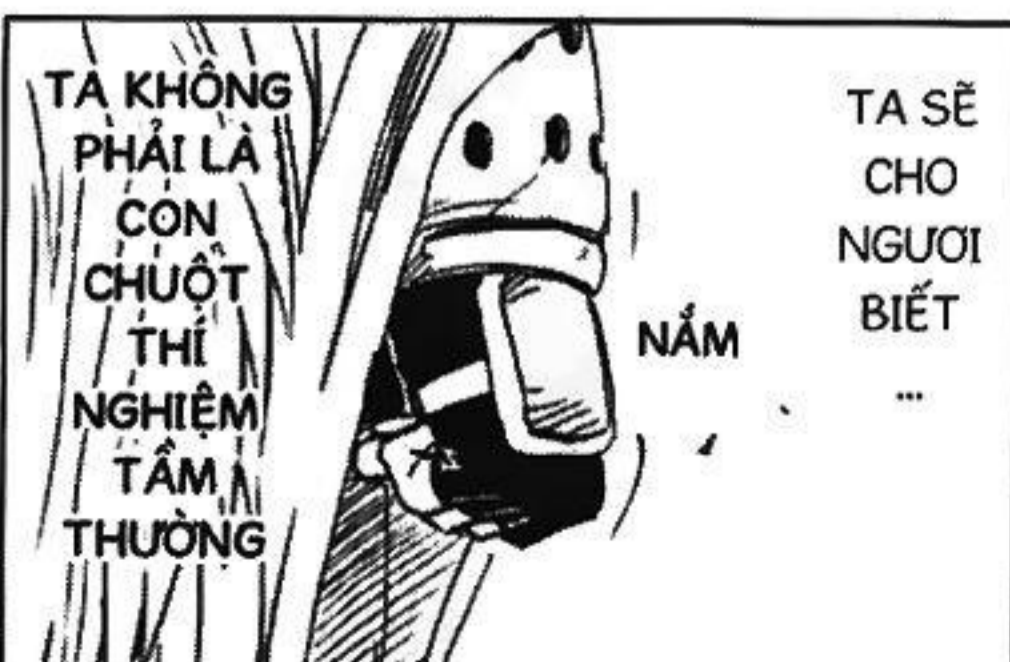







NARUTO

NGUỒN : BLOGTRUYEN.COM

SCAN : [NGANKVN](#)

Edit : [KYO](#)

CÁC NƠI KHÁC VUI LÒNG :

- GHI RÕ NGUỒN : BLOGTRUYEN.COM
- POST SAU BLOGTRUYEN.COM 2 CHAP
- KHÔNG XÓA-SỬA CREDIT VÀ TRANG TRUYỆN

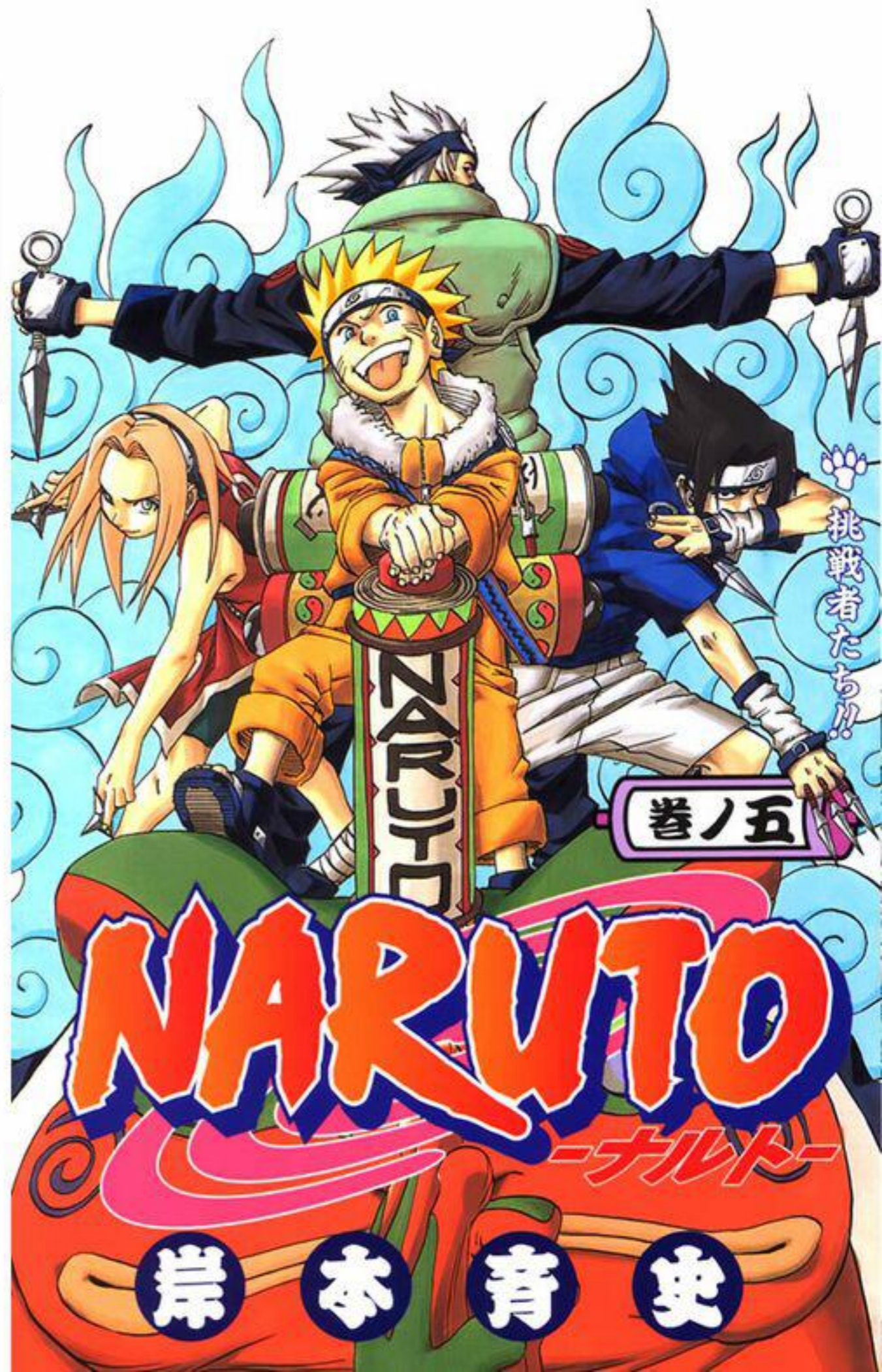



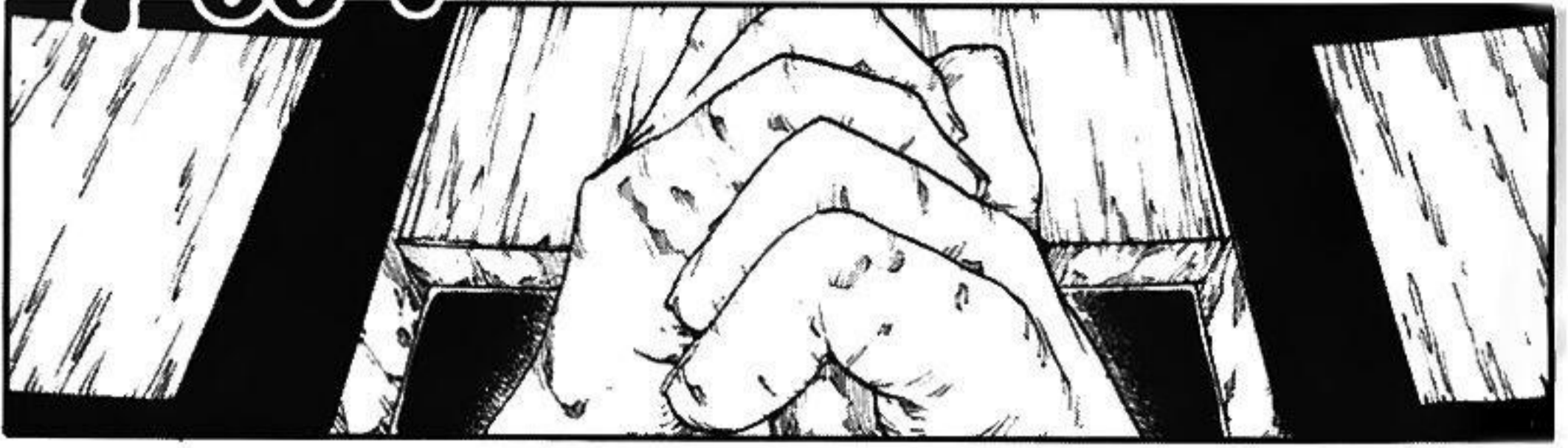













VẬY THÌ ...
XIN MỜI
NGÀI
HOKAGE
SAMA

ỪM
...

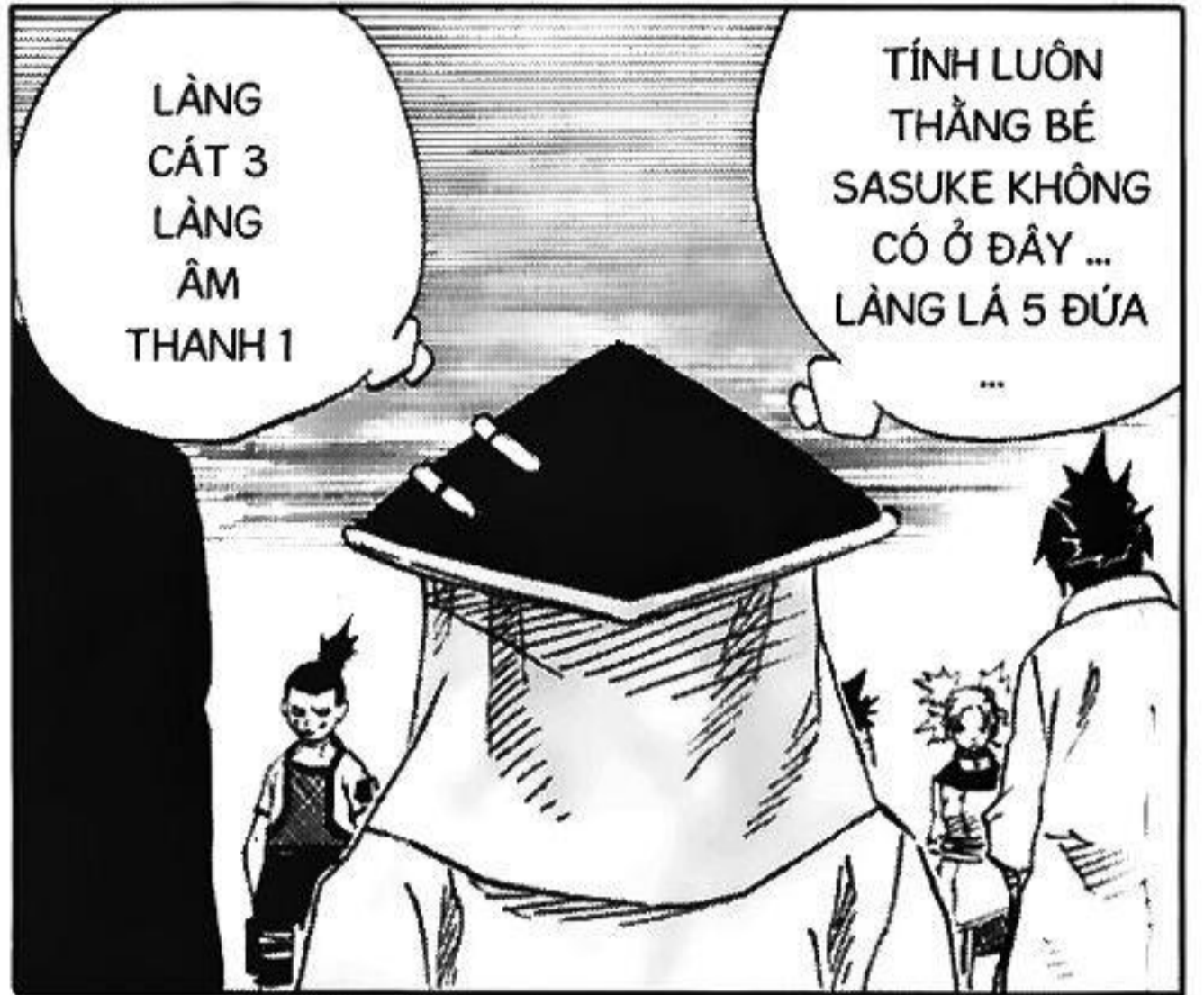

LÀNG
CÁT 3
LÀNG
ÂM
THANH 1

TÍNH LUÔN
THẺNG BÉ
SASUKE KHÔNG
CÓ Ở ĐÂY ...
LÀNG LÁ 5 ĐƯA
...



GIẢI THÍCH
NỘI DUNG
VÒNG THI
CHÍNH THỨC
...

VẬY THÌ
BÂY GIỜ,
TA SẼ BẮT
ĐẦU ...



CUỐI
CÙNG
CŨNG TỚI
...!!



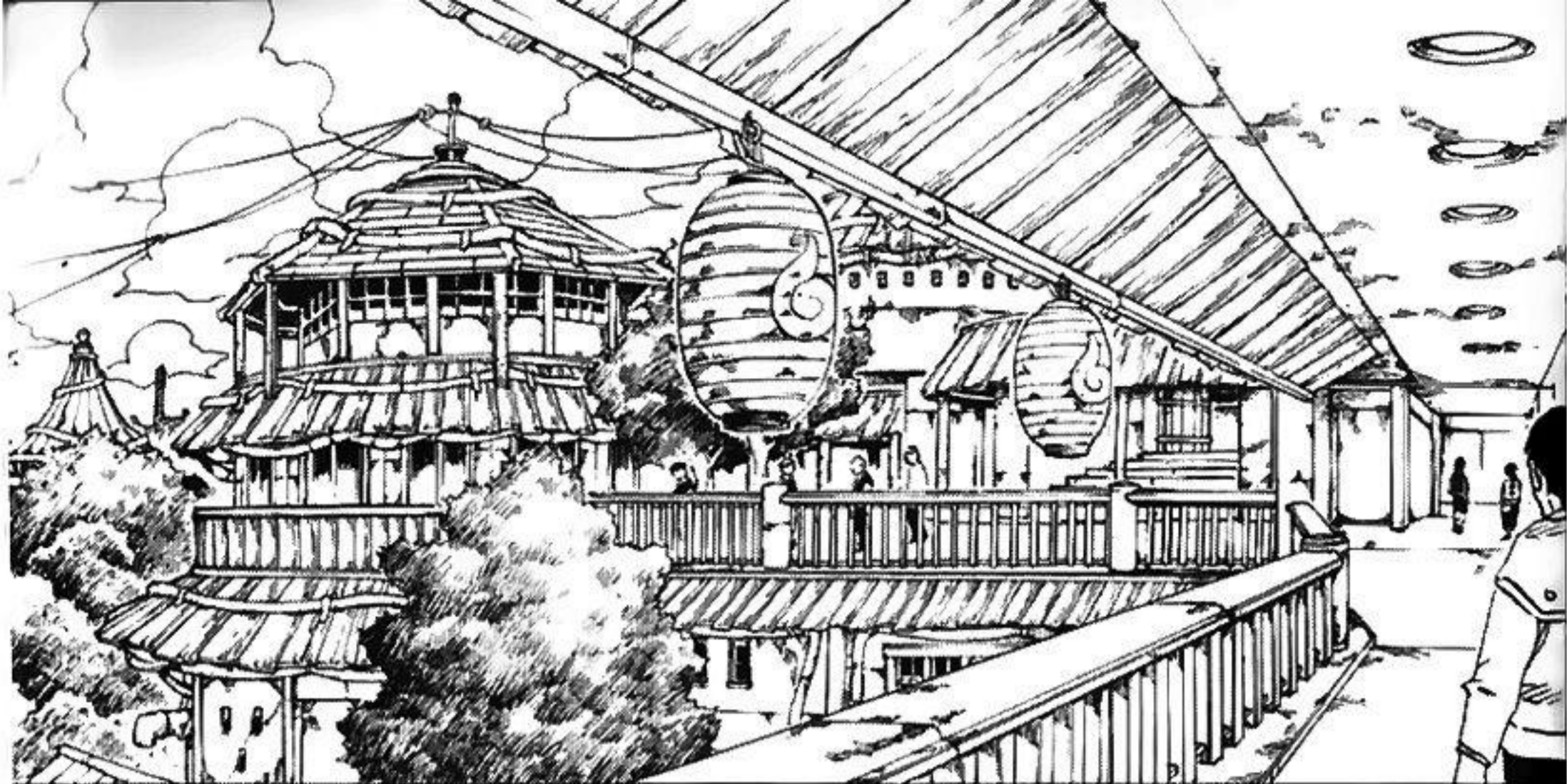













LÀNG ÂM THANH CŨNG LÀ MỘT TRONG SỐ ĐÓ

TỪ GIỜ CÁC LÀNG SẼ GIAO CHIẾN MỘT TRẬN KHỐC LIỆT VÀ TRIỀN MIÊN ...

NGÀI DỰ ĐỊNH LÀ NGƯỜI CHÂM NGÒI CHO CUỘC CHIẾN ĐÓ ...



LÀ UCHIHA SASUKE ĐÚNG KHÔNG

CHO CUỘC CHIẾN ĐÓ ?

VÀ CẬU ẤY CHÍNH LÀ ĐẠN ...



NHU TRƯỜNG HỢP BỌN DOSU, ZAKU, KIN

KHÔNG PHẢI DỌ TRỰC GIÁC



HI HI ...

TRỰC GIÁC CỦA NGƯỜI ... CŨNG GHÊ ĐẤY ...



MUỐN VẬY, TÔI PHẢI LÀM MỘT TRÒ NGỐC LÀ CHỊU DÍNH ĐÒN TẤN CÔNG CỦA CHÚNG ...

ĐỂ THU THẬP THÔNG TIN CỦA SASUKE KUN ...

TÔI BUỘC PHẢI NẮM RÕ SỨC MẠNH CỦA 3 NINJA ÂM THANH

NGÀI ĐỀ CAO TRỰC GIÁC CỦA TÔI QUÁ RỒI !



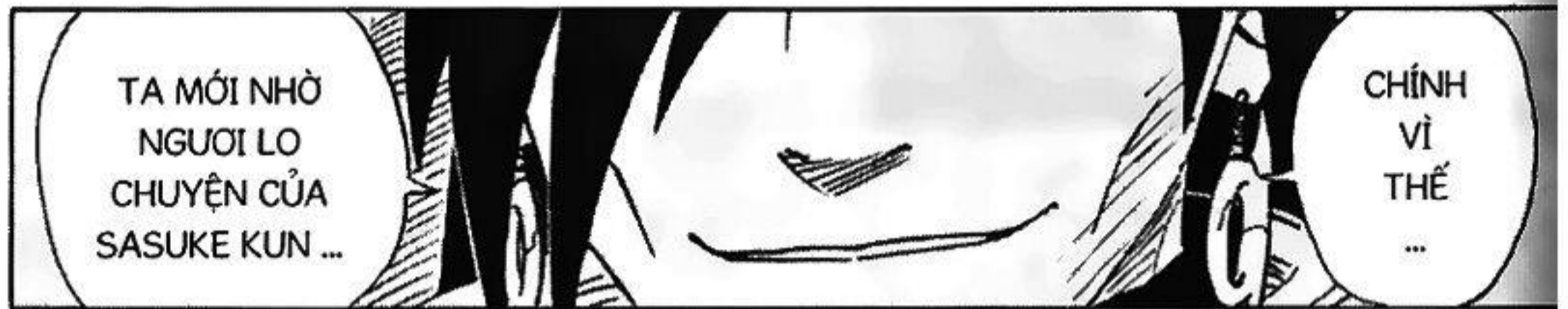
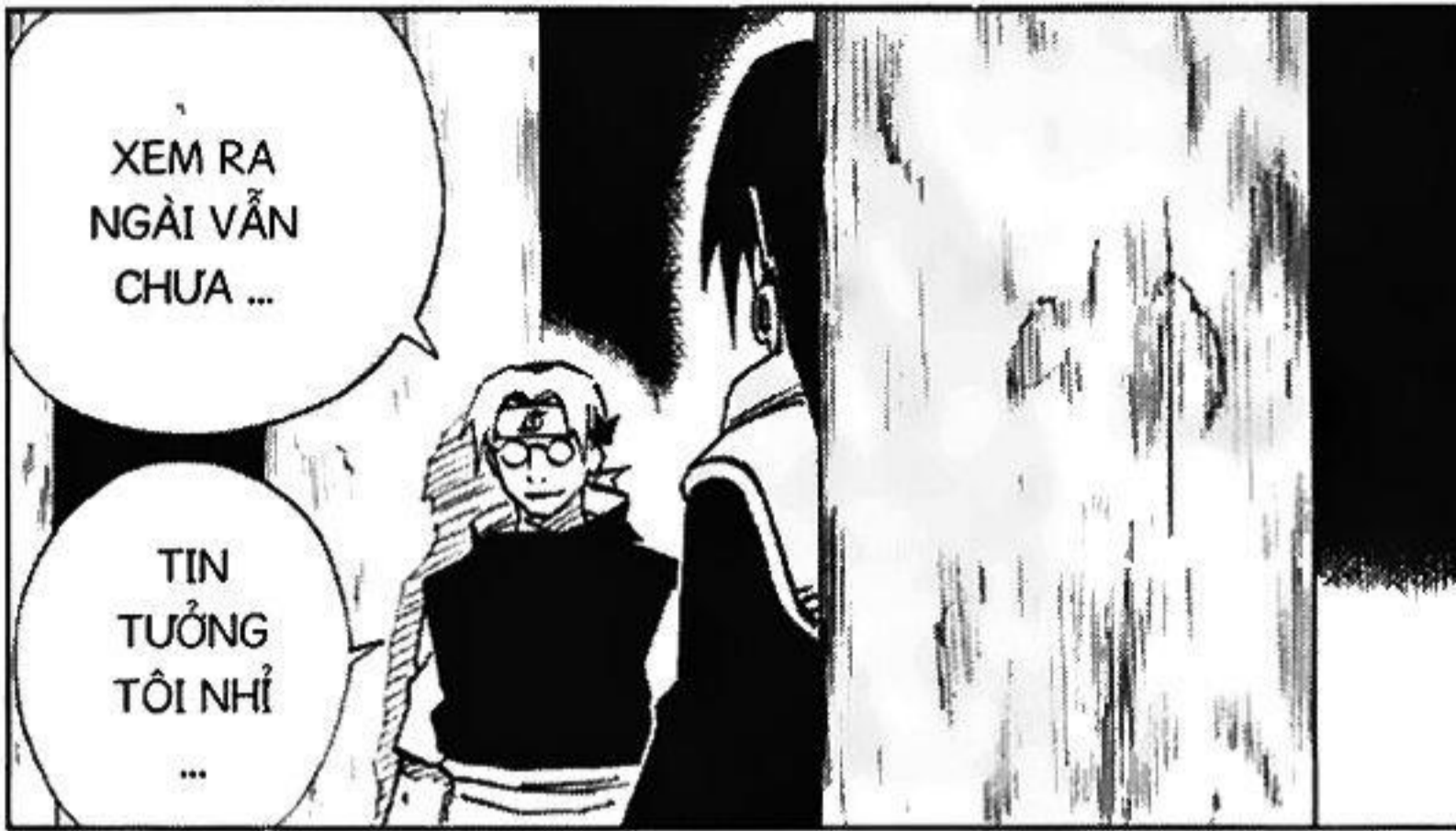













THÌ CHỈ CÒN
CÁCH GIẾT
SASUKE KUN
NGAY BÂY GIỜ



DÙ NGƯỜI
MẠNH ĐI
CHĂNG NỮA

...

CÙNG LẮM
CŨNG CHỈ CỠ
KAKASHI

...

NGƯỜI
KHÔNG THỂ
GIẾT ĐƯỢC
TA ĐÂU

...



.....



YÊN TÂM,
TA
TIN
NGƯỜI
MÀ

...

THÔI,
NGƯỜI ĐI
ĐƯỢC
RỒI!



ỢC



HÌ HÌ ...
TA ĐUA
THÔI ...



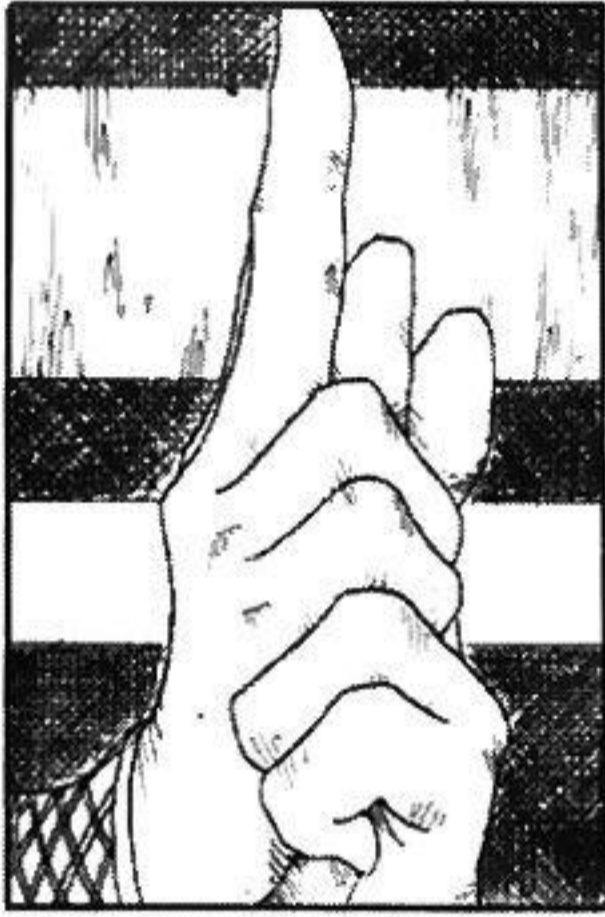

ĐANG
SUY
TÍNH
GÌ ĐÂY

HI HI ...
SẮC
MẶT
ĐÓ

VỤT

BỘP



MỖI NGƯỜI
CHÍNH LÀ ĐẠI
DIỆN CHO SỨC
MẠNH QUÂN SỰ
NƯỚC MÌNH

TA MUỐN CÁC
EM PHÁT HUY
HẾT SỨC
MẠNH CHO
MỌI NGƯỜI
THẤY

NHU TA CÓ NÓI
TRƯỚC, Ở VÒNG THI
CHÍNH THỨC, TRẬN
ĐẤU CỦA CÁC EM SẼ
ĐƯỢC DIỄN RA
TRƯỚC MẶT MỌI
NGƯỜI



SẼ BẮT ĐẦU
SAU 1 THÁNG
NỮA !

CHÍNH VÌ
THẾ,
VÒNG CHÍNH
THỨC ...

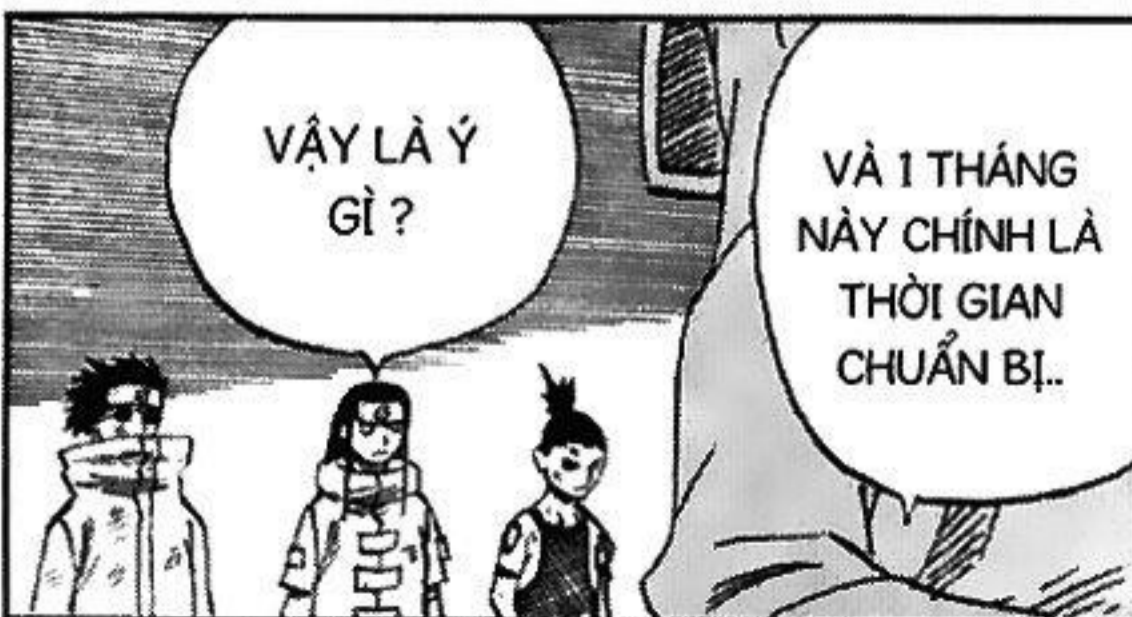

VẬY LÀ Ý
GÌ ?

VÀ 1 THÁNG
NÀY CHÍNH LÀ
THỜI GIAN
CHUẨN BỊ..



SAO KHÔNG
LÀM NGAY
BÂY GIỜ
LUÔN CHO
RỒI ?







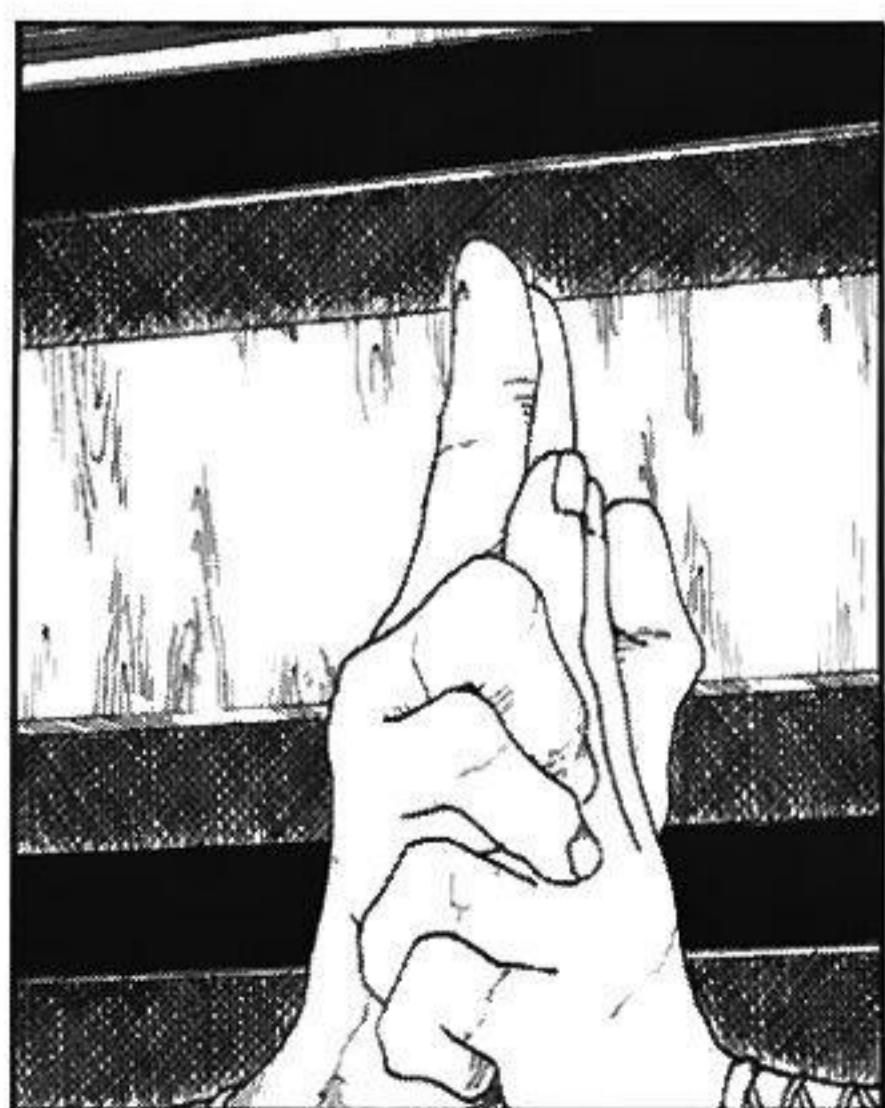





CẢ HAI TA ĐỀU QUÁ NỔI BẬT

VÀ THẬT BẤT HẠNH VÌ CẢ 2 TA ĐỀU LỘT VÀO MẮT XANH CỦA OROCHIMARU SAMA ...



XUẤT SẮC QUÁ CŨNG KHÔNG NÊN ...

BUỐC

BUỐC

HỪ ...







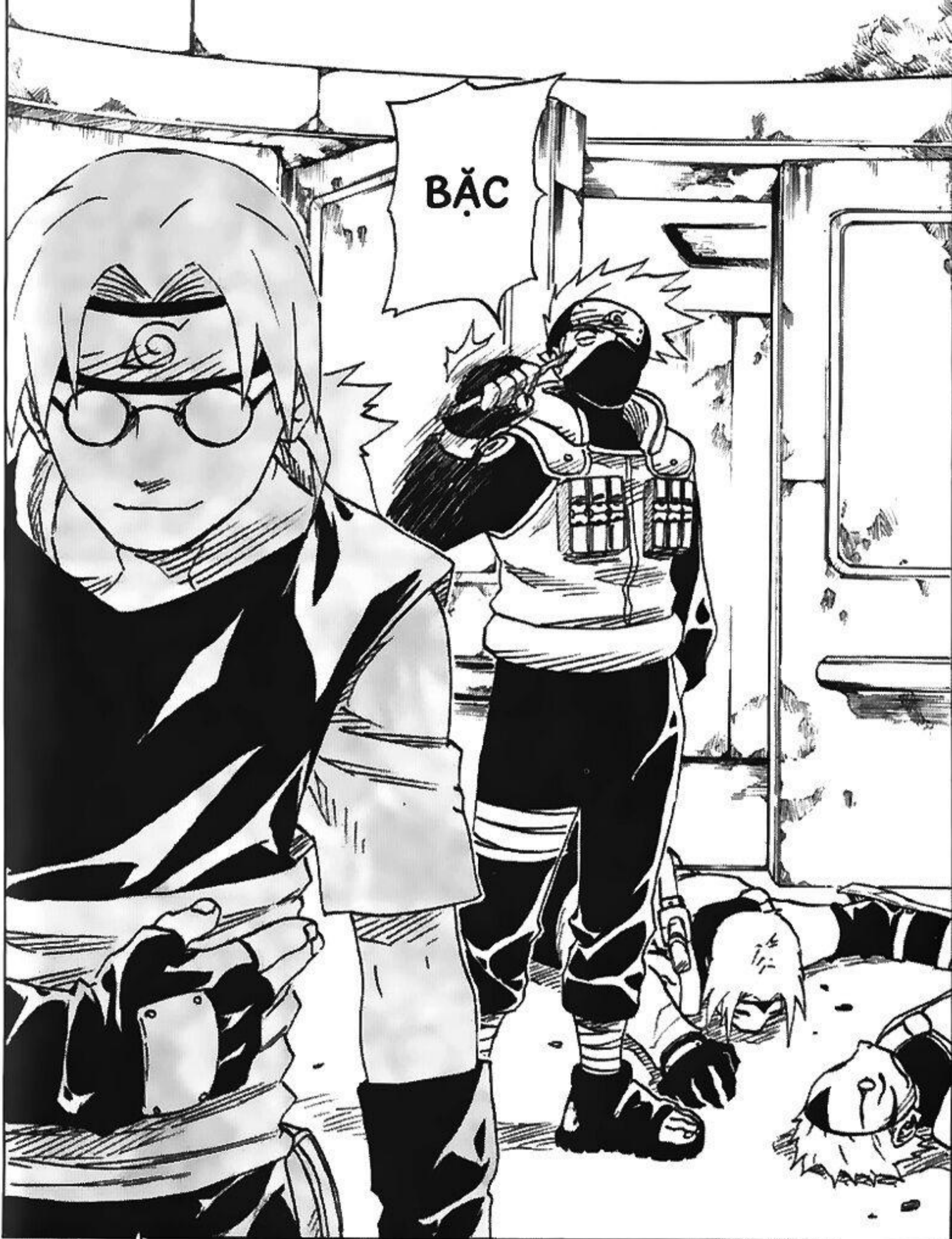

BẶC













NARUTO

NGUỒN : BLOGTRUYEN.COM

SCAN : [NGANKVN](#)
Edit : [KYO](#)

CÁC NƠI KHÁC VUI LÒNG :

- GHI RÕ NGUỒN : BLOGTRUYEN.COM
- POST SAU BLOGTRUYEN.COM 2 CHAP
- KHÔNG XÓA-SỬA CREDIT VÀ TRANG TRUYỆN

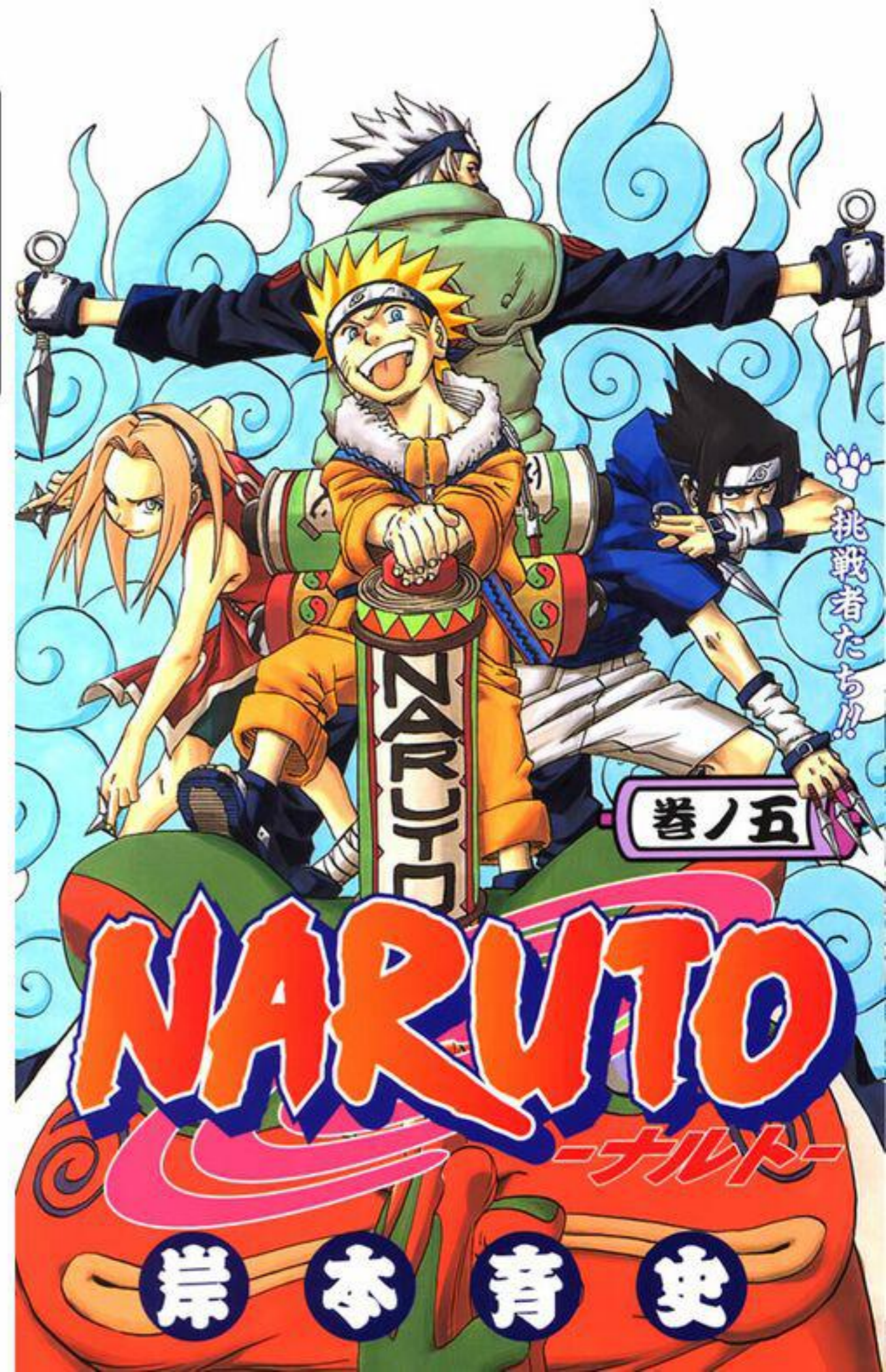





NHẶN Y : THẦY THUỐC NINJA







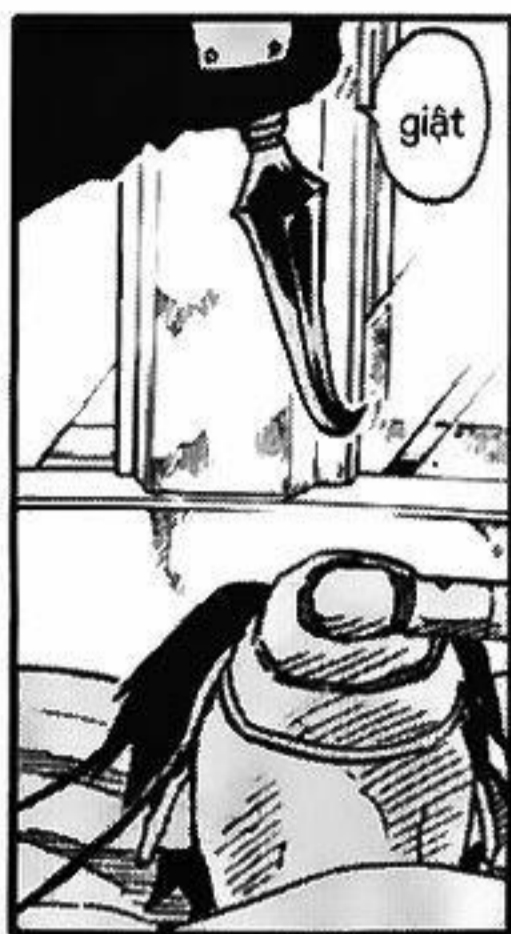



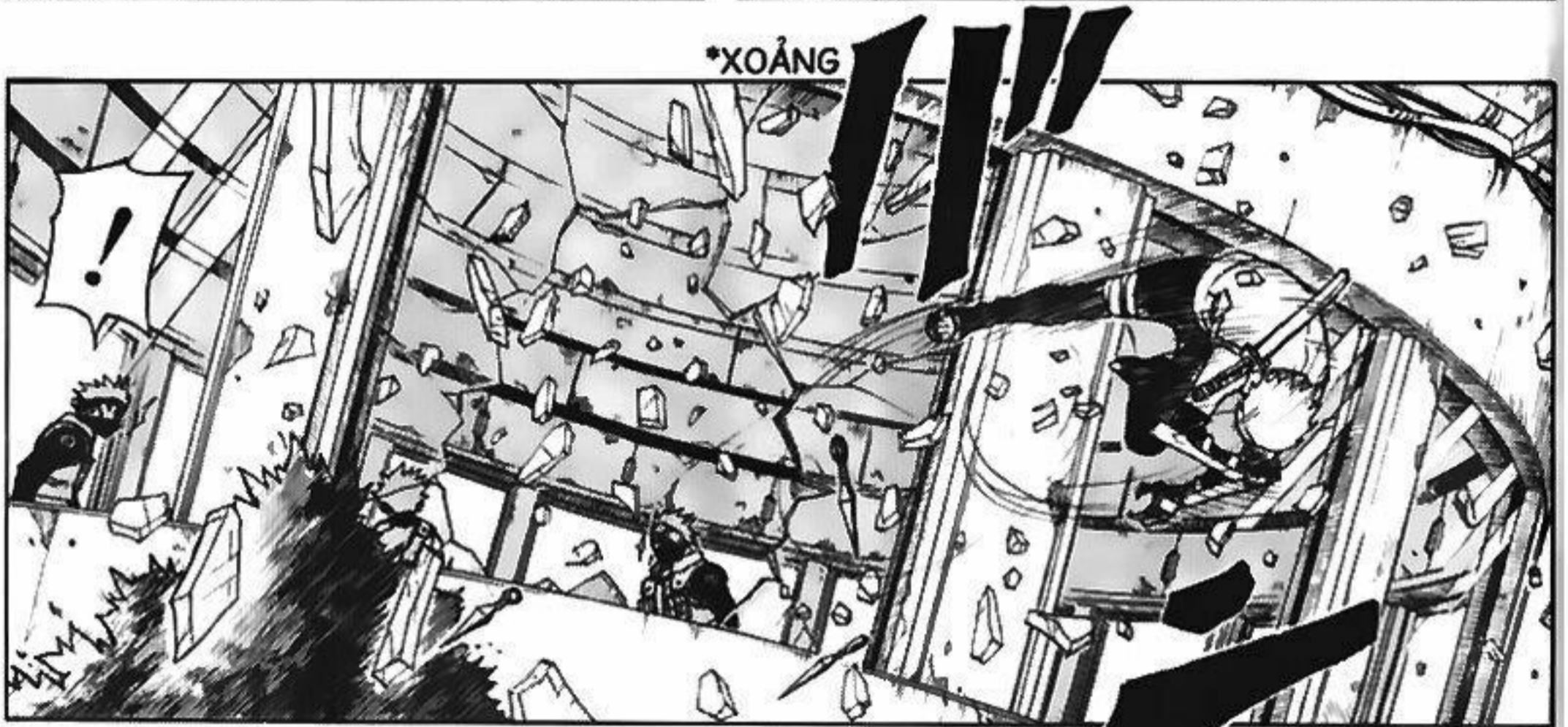









TA SẼ
CÔNG BỐ
LỊCH ĐẤU
CỦA
VÒNG
THI
CHÍNH
THỨC !!

ĐƯỢC
RỒI,
VẬY
GIỜ
...



ỪM
!

VẬY LÀ
CẬU BÉ KIA
SỐ 4 ...



XẾP LỊCH
BẰNG TRÒ
RÚT THĂM
HỎI NẤY
SAO
!

CÁI GÌ

!!?



ẶC



IBIKI,
ĐƯA
BẢNG
PHÂN BỐ
RA ĐI

VÀNG
...

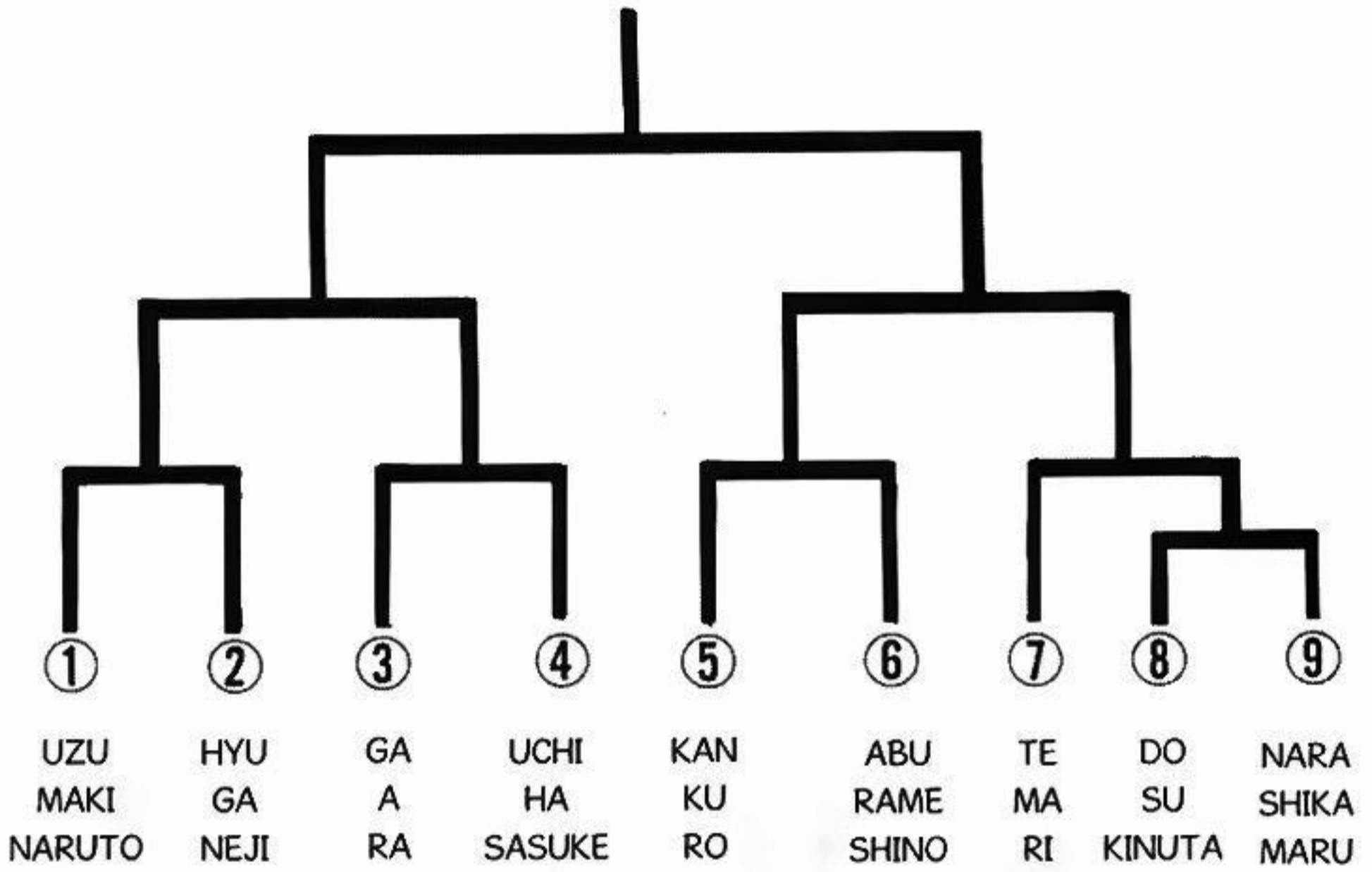
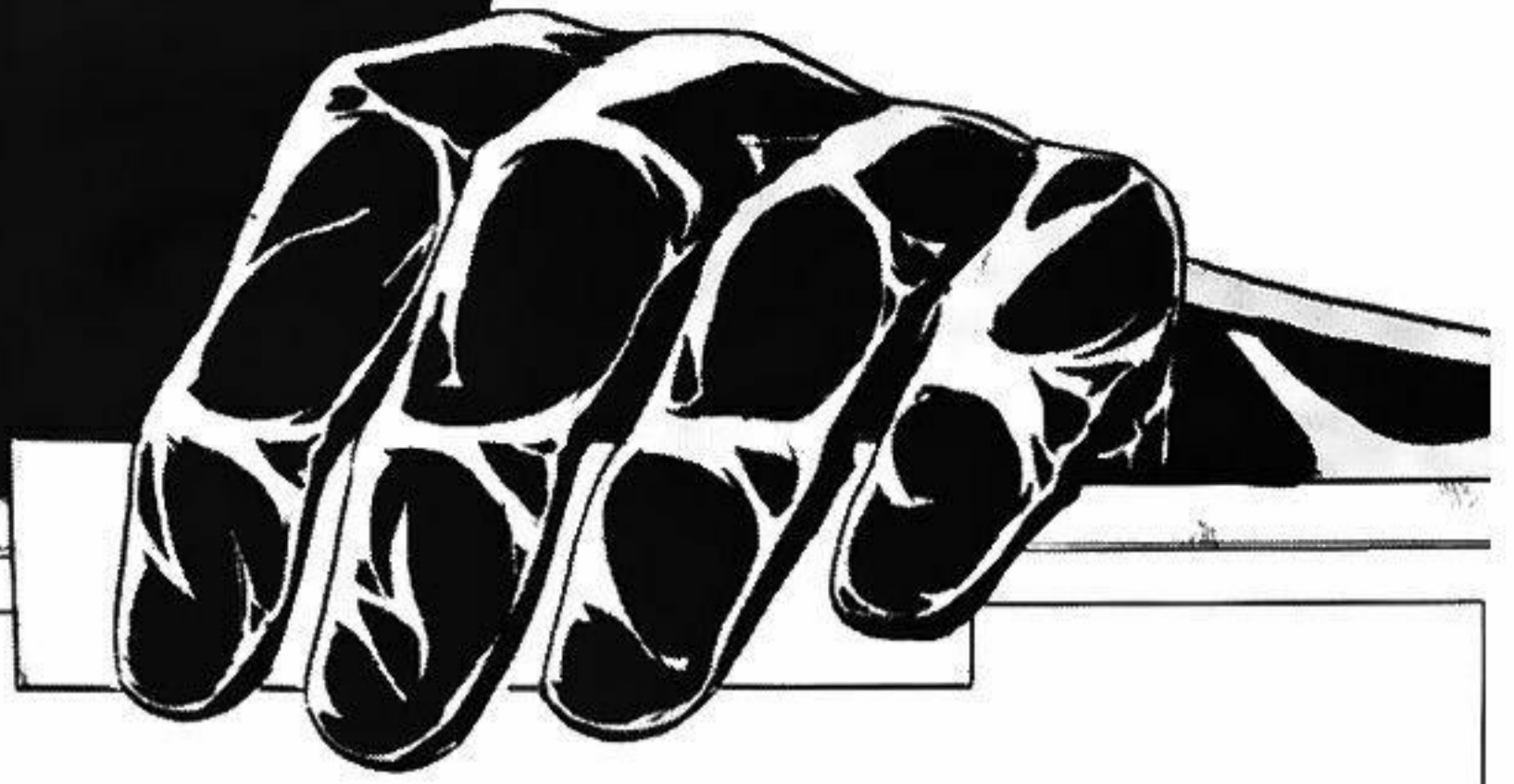





TỨC LÀ ...
CHỈ CÓ MỘT
NGƯỜI ĐƯỢC
THÀNH CHUNIN
THÔI SAO ?

CHỈ CÓ
MỘT
NGƯỜI
GIÀNH
CHIẾN
THẮNG ...

TỔ CHỨC
THI ĐẤU
THỂ NÀY
ĐỒNG
NGHĨA VỚI
VIỆC ...



CÁC EM SẼ ĐƯỢC
ĐÁNH GIÁ XEM
CÓ ĐỦ TƯ CHẤT
TRỞ THÀNH
CHUNIN HAY
KHÔNG ...

CÁC VỊ GIÁM
KHẢO THÔNG
QUA TRẬN ĐẤU
SẼ BÌNH PHẨM
TỪNG NGƯỜI ...



GIÁM KHẢO
VÒNG THI
CHÍNH THỨC
NÀY BAO GỒM
TA, KAZEKAGE

KHÔNG !
SAI RỒI

ĐẠI DIỆN CÁC
NƯỚC ỦY THÁC
VÀ CÁC NINJA
ĐÚNG ĐẦU CÁC
NƯỚC ĐÓ



NHỮNG NGƯỜI
Ở ĐÂY ĐỀU CÓ
KHẢ NĂNG
TRỞ THÀNH
CHUNIN
?

VẬY TỨC
LÀ
...



NHUNG VẪN
CÓ THỂ TRỞ
THÀNH
CHUNIN
ĐƯỢC

VÍ DỤ, CÓ
NGƯỜI
THUA NGAY
TRẬN ĐẤU
...

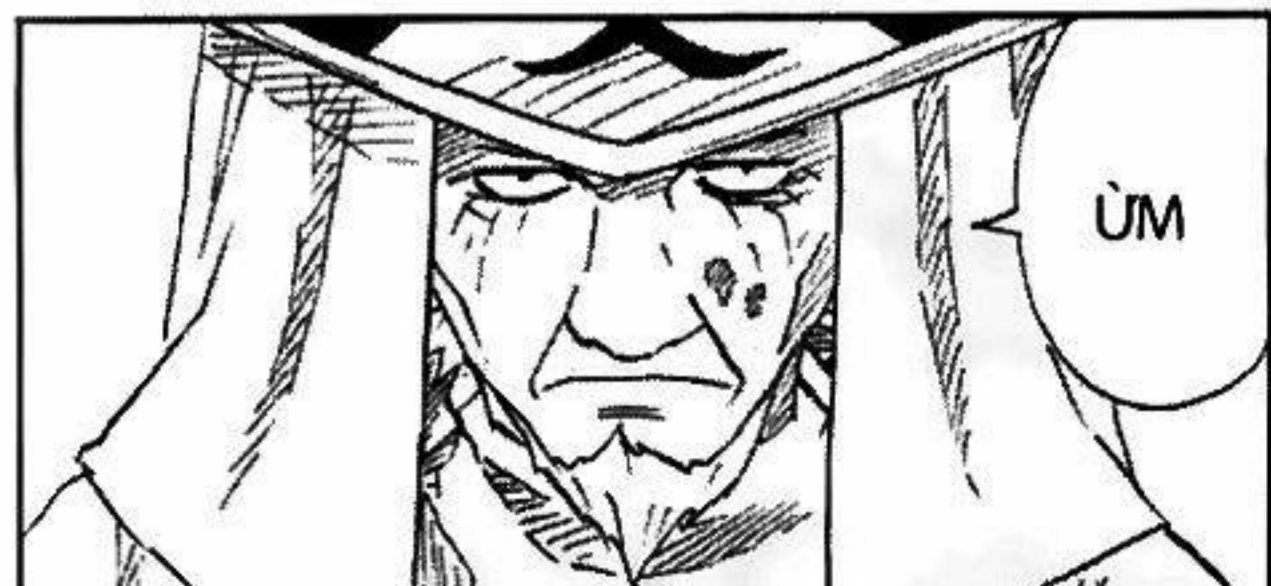

ỪM





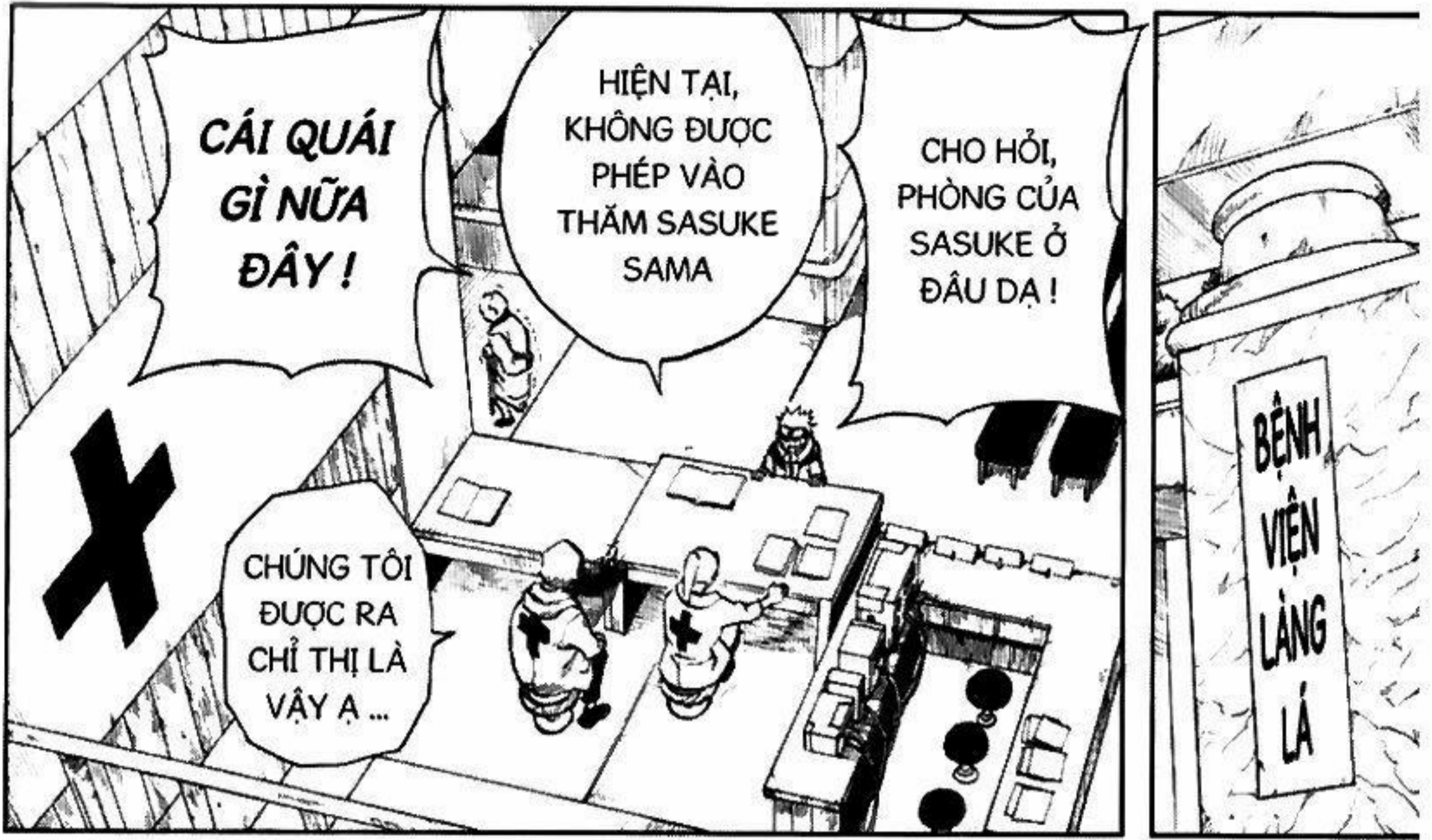



[THẾ GIỚI CỦA MASASHI KISHIMOTO]

TIỂU SỬ THỜI XA XUA 13

SAU KHI BIẾT TỚI "AKIRA", CÁCH NHÌN TRANH CỦA TÔI PHẢI NÓI LÀ THAY ĐỔI CỰC KÌ. TÔI TỰ HỎI OOTOMO SENSEI, TÁC GIẢ CỦA "AKIRA" LÀ NGƯỜI THẾ NÀO NHỈ, CŨNG ĐÃ TÌM HIỂU RẤT NHIỀU NHUNG VẪN KHÔNG BIẾT ĐƯỢC. CHO NÊN TÔI CHỈ CÒN CÁCH NGHĨ ÔNG LÀ MỘT NGƯỜI RẤT ĐỘC ĐÁO.

(LÀ NGƯỜI DUY NHẤT CÓ SỨC ẢNH HƯỞNG TỚI TÔI, SAU TORIYAMA SENSEI ĐẤY ...)

TẠI SAO TRANH CỦA TORIYAMA SENSEI VÀ OOTOMO SENSEI LẠI CÓ SỨC THU HÚT ĐẾN THẾ, TÔI NGHĨ HOÀI CŨNG KHÔNG RA NHUNG CÓ THỂ LÝ GIẢI ĐƯỢC 2 ĐIỂM SAU. TRANH CỦA 2 NGƯỜI ĐỀU QUÁ ĐỘC ĐÁO VÀ ĐƯỜNG NÉT CHI TIẾT THÌ QUÁ TUYỆT. CÓ THỂ CẢM NHẬN ĐƯỢC HIỆU ỨNG, CÁCH THIẾT KẾ VÀ CÁCH XỬ LÝ CÁC CHI TIẾT NHỎ TRONG TRANH CỦA 2 ÔNG RẤT KHÁC NHỮNG NGƯỜI KHÁC. NÓI TÓM LẠI, TRANH CÓ SỨC THU HÚT TỨC LÀ TRANH PHẢI ĐỘC ĐÁO. VÀ TÔI BẮT ĐẦU CÓ SUY NGHĨ, CÓ VẼ BẮT CHƯỚC TRANH CỦA NGƯỜI KHÁC CŨNG CHỈ CÓ Ý NGHĨA GÌ NỮA.

TỪ ĐÓ, TÔI BẮT ĐẦU CỐ VẼ TRANH ĐỘC ĐÁO, NHUNG CÀNG VẼ LẠI CÀNG GIỐNG TRANH NHÁI, KHÔNG THỂ NÀO ĐỘC ĐÁO ĐƯỢC. NHU VẬY LÀ KHÔNG ỔN, THẾ LÀ TÔI QUYẾT ĐỊNH ĐI XEM TRANH CỦA CÁC MANGAKA KHÁC ĐỂ CÓ CÁI NHÌN SÂU SẮC HƠN. NHUNG THẬT SỰ KHÔNG CÓ AI TUYỆT NHƯ NGƯỜI NÀY CẢ, VẬY LÀ CÔNG CUỘC TÌM KIẾM THẤT BẠI.

VÀ LÚC ĐÓ TÔI NHẬN RA, KHÔNG HIẾM TRƯỜNG HỢP TRANH CỦA MANGAKA NÀO VỪA MỚI NHÌN MÀ THẤY TUYỆT TỨC LÀ CÓ ẢNH HƯỞNG CỦA 2 NGƯỜI NÀY, ĐẠI KHÁI LÀ PHẢI CHỊU ẢNH HƯỞNG CỦA AI ĐÓ THÌ CŨNG ĐỘC ĐÁO. TÔI NGHĨ RẰNG MÌNH PHẢI VẼ CHO ĐƯỢC CHI TIẾT GIỐNG NHƯ OOTOMO SENSEI NÊN TÔI BẮT ĐẦU NHÁI THEO OOTOMO SENSEI, TỪ NĂM THỨ 2 CHO ĐẾN ĐẦU NĂM 3 TRUNG HỌC, TÔI MUA TOÀN BỘ KỊCH BẢN TRANH (TRANH VẼ CẢNH ĐỂ QUAY PHIM), TRUYỆN COMIC, ANIME COMIC VÀ BẮT CHƯỚC THEO. VỪA NHÁI VỪA NGHĨ RA ĐỦ LOẠI TRANH ĐỘC ĐÁO, TÔI ĐÃ RẤT CHĂM CHỈ THEO HƯỚNG SUY NGHĨ ĐÓ. NĂM TRUNG HỌC CỦA TÔI CHỈ ĐƠN GIẢN NHƯ THẾ ĐẤY (THẬT RA, SAU ĐÓ TÔI CÒN TÌNH CỜ THẤY ĐƯỢC TRANH CỦA 2 TÁC GIẢ KHÁC Ý TƯỞNG CŨNG RẤT ĐỘC ĐÁO NHUNG ĐỂ DỊP SAU NÓI VẬY)

NARUTO

NGUỒN : BLOGTRUYEN.COM

SCAN : NGANKVN

Edit : [KYO](#)

CÁC NƠI KHÁC VUI LÒNG :

- GHI RÕ NGUỒN : BLOGTRUYEN.COM
- POST SAU BLOGTRUYEN.COM 2 CHAP
- KHÔNG XÓA-SỬA CREDIT VÀ TRANG TRUYỆN

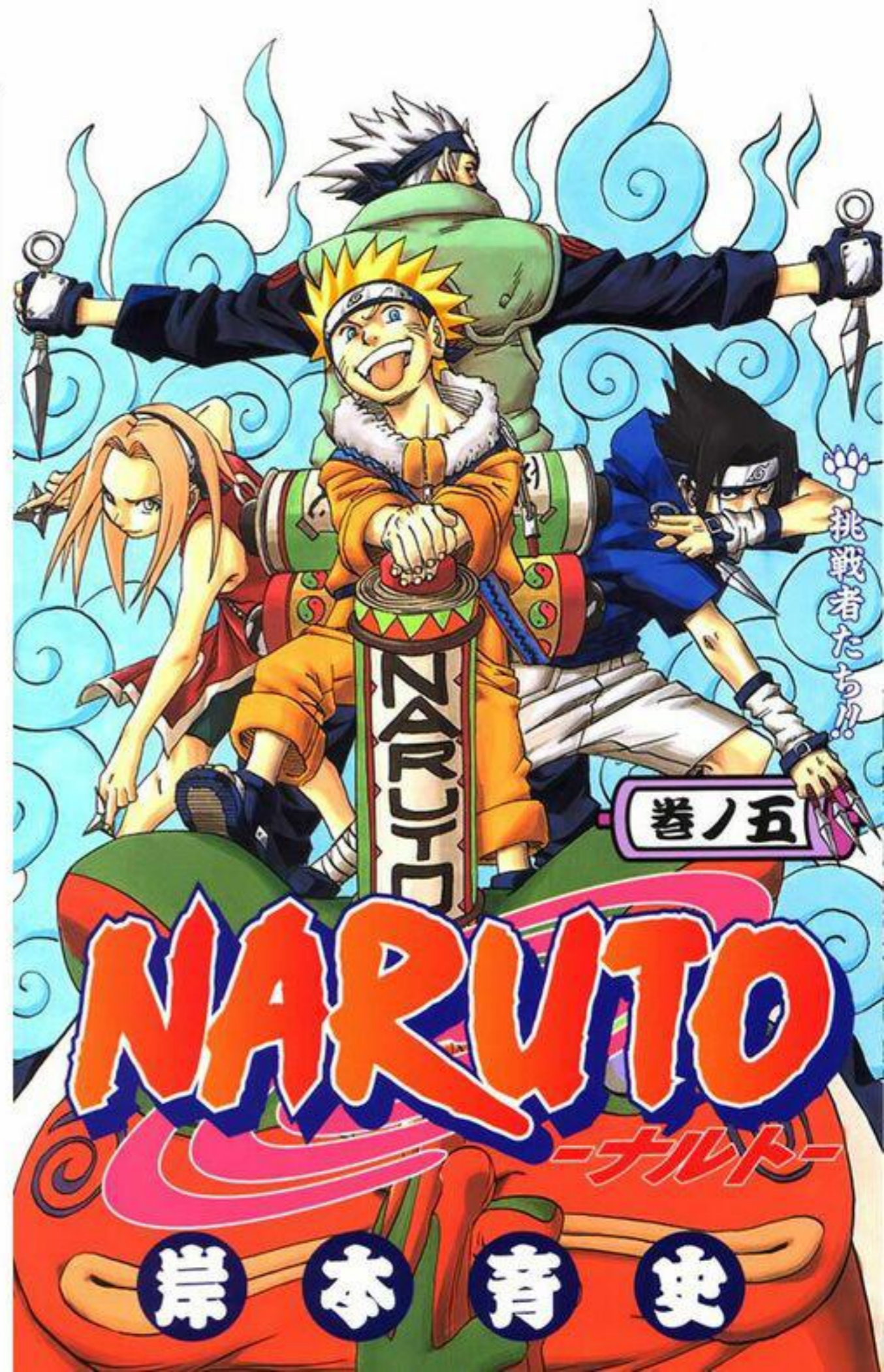

 90 :

HUẤN LUYỆN, LÀM SAO ĐÂY !?



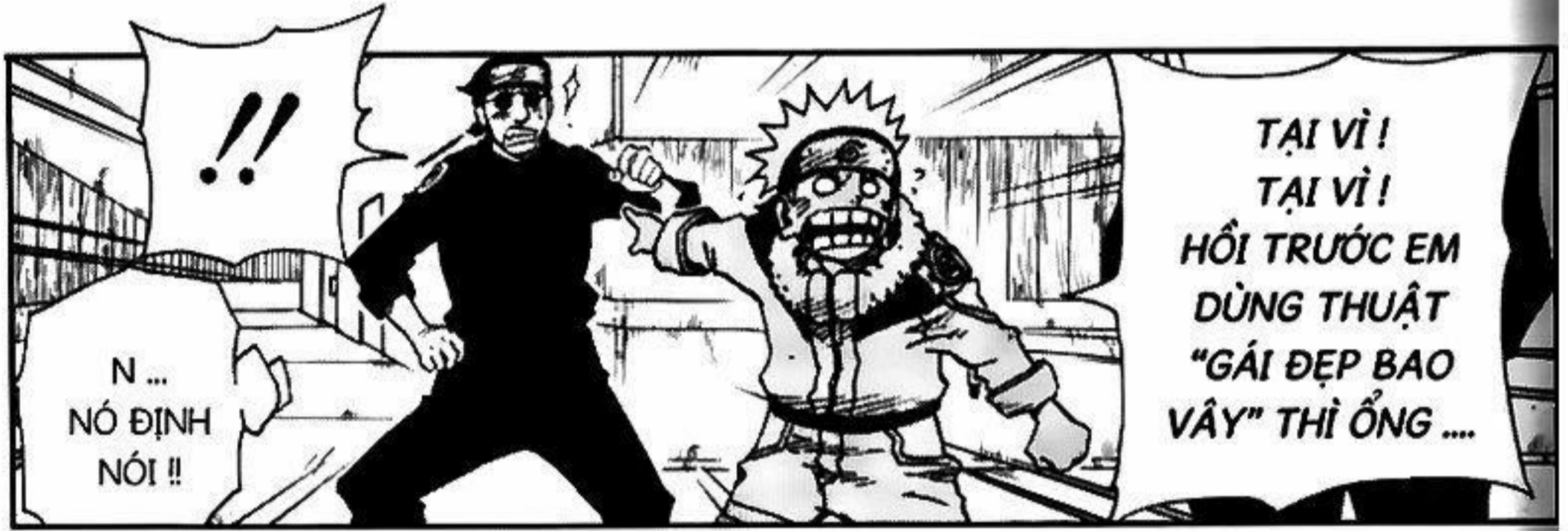



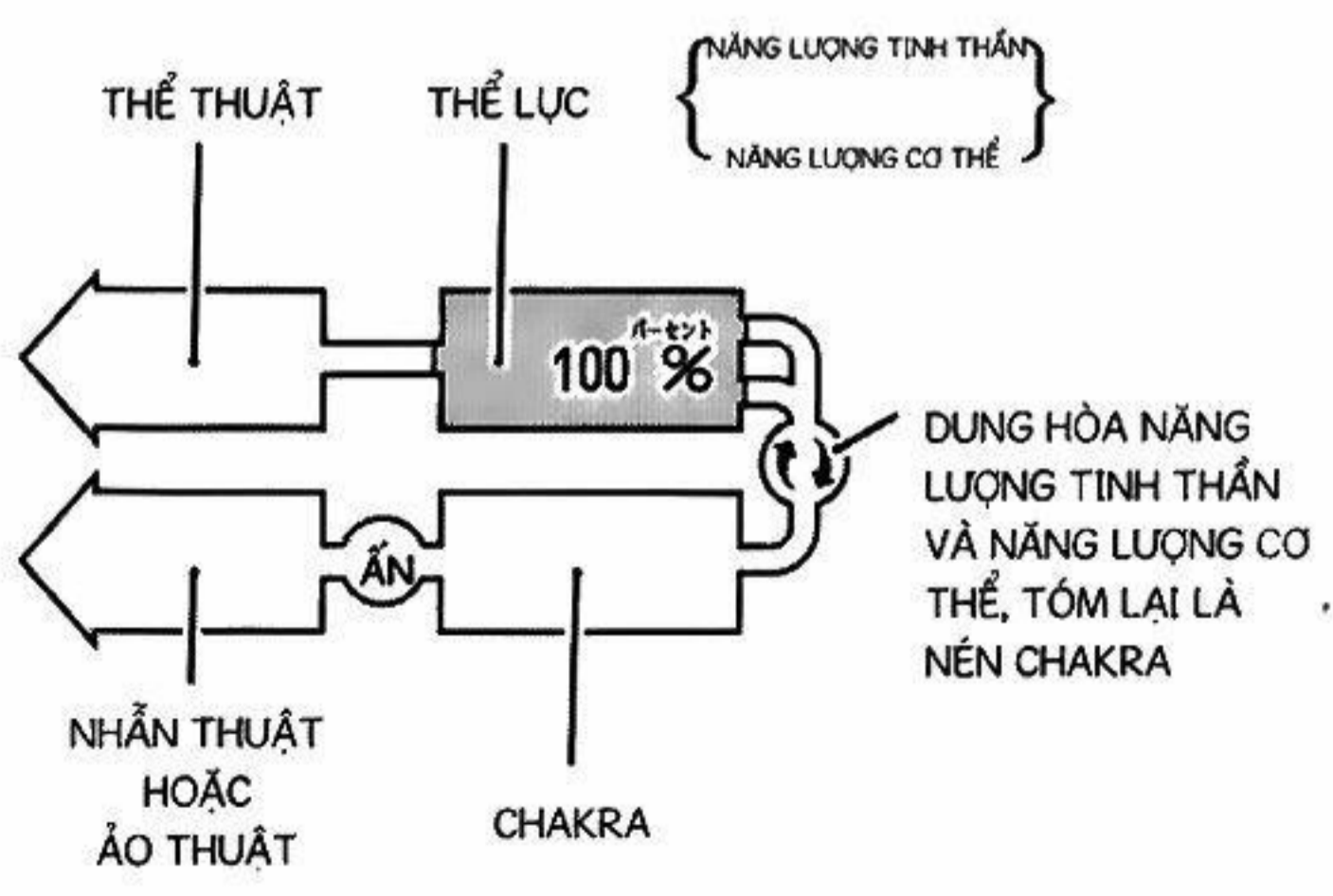
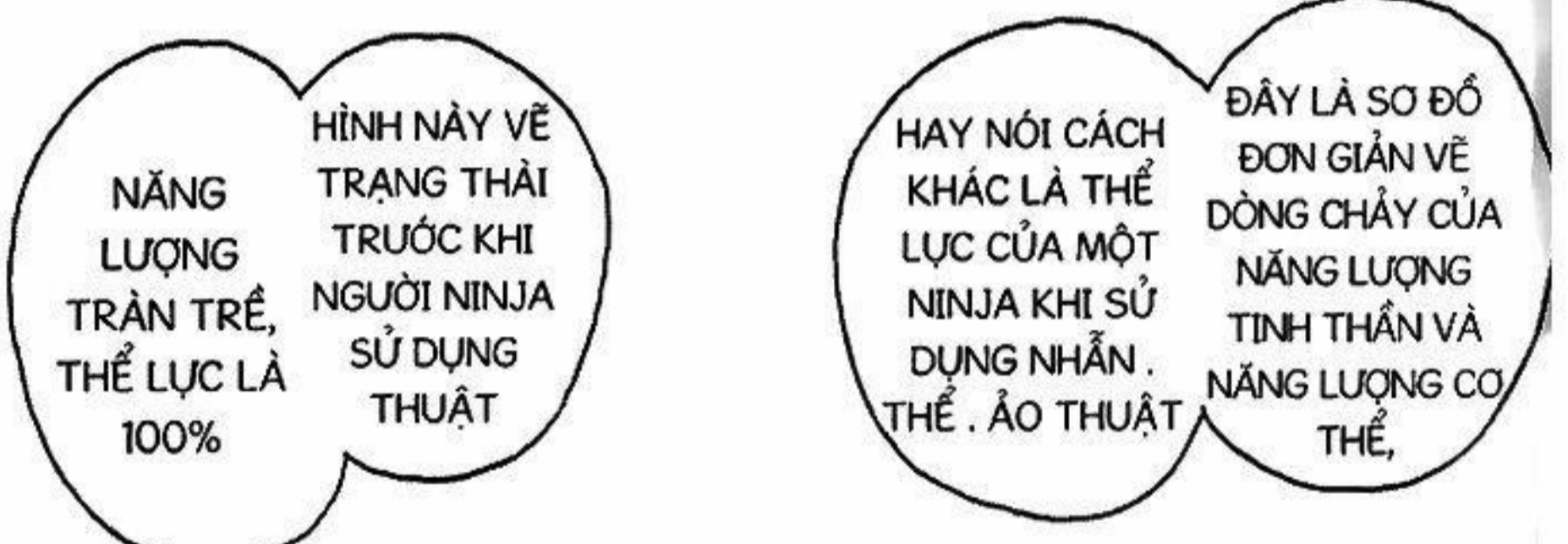



MỘC
DIỆP
TOÀN
PHONG
!!!



ĐÁNH
ĐÂY
!

CÁCH ĐIỀU
CHỈNH THỂ
LỰC RẤT
ĐƠN GIẢN

TRƯỜNG
HỢP SỬ
DỤNG
THỂ
THUẬT
...

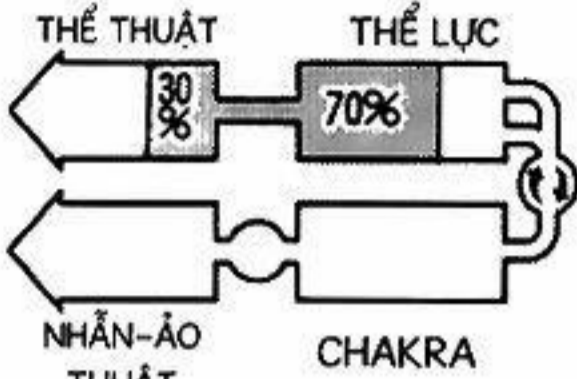

[KHI SỬ DỤNG THỂ THUẬT, LEE XÀI HẾT 30% THỂ LỰC, CÒN LẠI 70%]

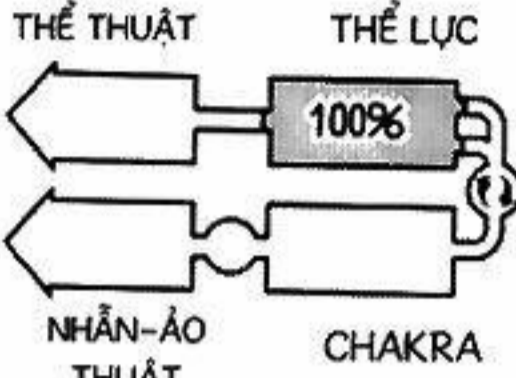

KHÔNG CẦN
CHỈ NHỮNG NIỆM ẮN, CŨNG
CHIÊU THỂ KHÔNG CẦN TỚI
THUẬT QUAN CHAKRA (THẬT
TRỌNG MỚI RA, CŨNG CÓ
TIÊU HAO THỂ LỰC TRƯỜNG HỢP
NGOẠI LỆ)

H
M
M
M
!!!



PHÙ
ĐANG
TẠO RA
CHAKRA
ĐÓ!

TUY NHIÊN,
KHI SỬ DỤNG
NHÃN THUẬT
HAY ẢO
THUẬT

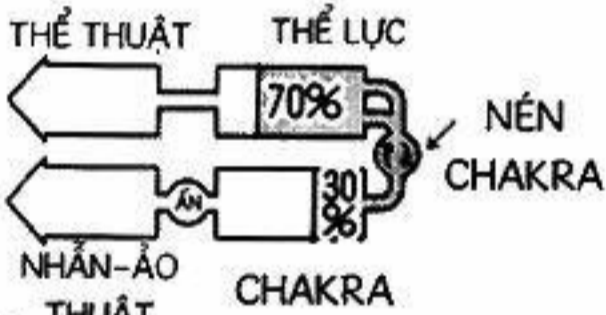

[NARUTO NÉN 30% CHAKRA TỪ THỂ LỰC, CÒN LẠI 70%]

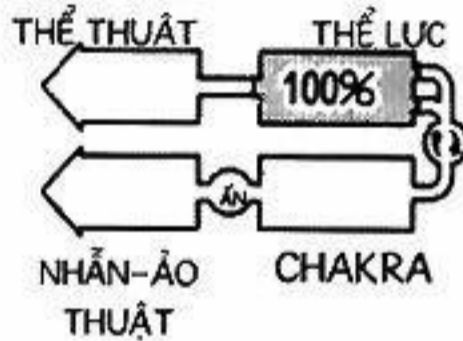

TRƯỚC TIÊN, CẦN
PHẢI NÉN ĐƯỢC
LƯỢNG CHAKRA
CẦN THIẾT CHO
LOẠI NHÃN-ẢO
THUẬT MÀ MÌNH
MUỐN THI TRIỂN

LƯU Ý, NẾU
ĐỂ CHAKRA
0%, TỨC THỂ
LỰC 0% THÌ
SẼ BỊ CHẾT
ĐÂY

DỄ NHIÊN
NĂNG LƯỢNG
SỬ DỤNG CHO
ẢO-THỂ-
NHÃN THUẬT
SẼ BỊ TIÊU
HAO DẦN

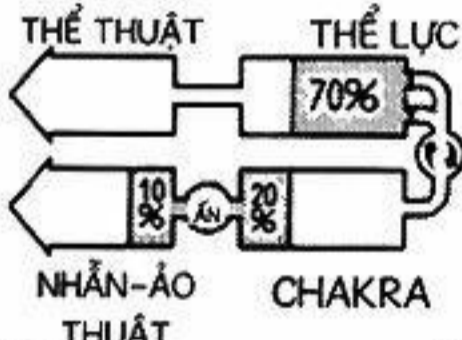
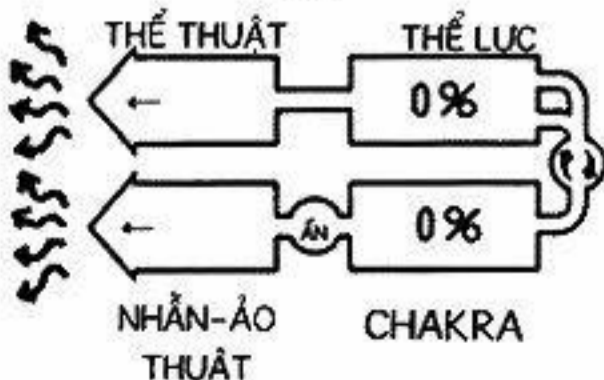

[SỬ DỤNG 30% CHAKRA CHO THUẬT ẢNH PHẢN THÂN TỪ 30% CHAKRA ĐÃ NÉN]

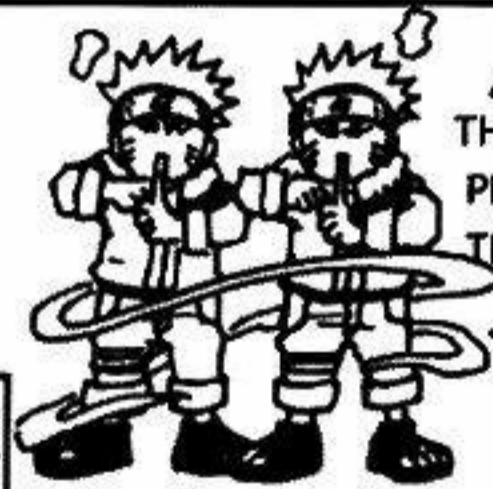

THUẬT
PHẢN
THÂN

SAU ĐÓ PHẢI
ĐIỀU CHỈNH
LƯỢNG
CHAKRA
THÍCH HỢP
TƯƠNG
ỨNG VỚI

KIỂU 1

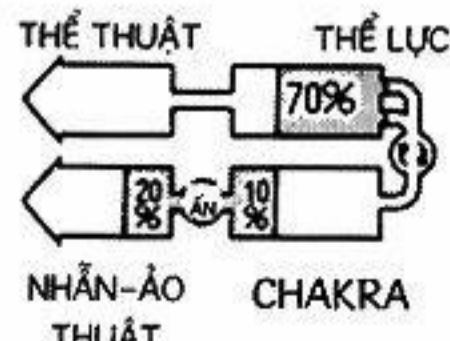

[THUẬT BIẾN THÂN SỬ DỤNG 20% CHAKRA]

THUẬT
BIẾN
THÂN



KIỂU 2

LOẠI THUẬT
MÌNH XÀI
BẰNG CÁCH
THAO TÁC
CÁC ẮN PHỨC
TẬP!

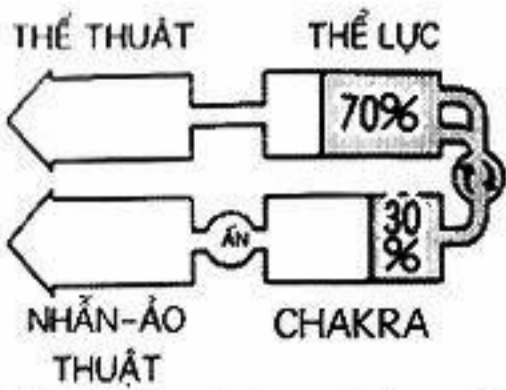

TRƯỜNG HỢP CỦA SAKURA KUN, KHI MUỐN THI TRIỂN THUẬT NÀY ... EM ẤY CÓ THỂ NÉN VỪA ĐỦ 30% CHAKRA

TIẾP THEO, SẼ NÓI VỀ PHẦN NÂNG CAO CỦA THUẬT PHÂN THÂN TA ĐÃ GIẢI THÍCH BAN NÀY

VÍ DỤ, NẾU PHÂN THÂN 4 NGƯỜI THÌ PHẢI CẦN TỚI 30% LƯỢNG CHAKRA

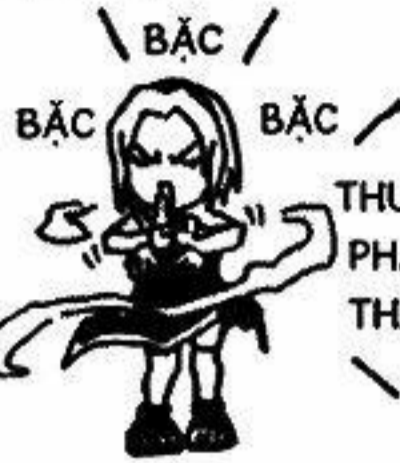
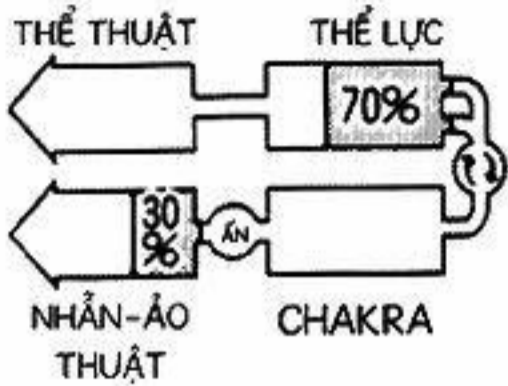

SAU ĐÓ, VÌ NGAY CẢ KHI NIỆM ẤN CŨNG CÓ THỂ ĐIỀU CHỈNH TỐT LƯỢNG CHAKRA NÊN ...

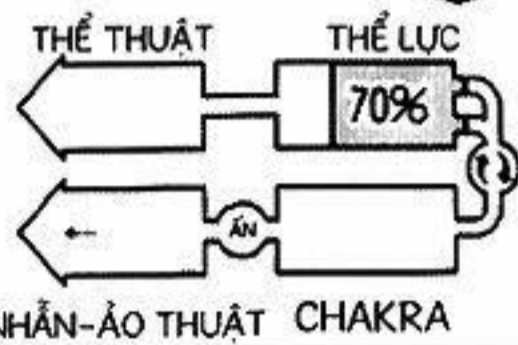

EM ẤY CÓ THỂ PHÂN THÂN 4 NGƯỜI THÀNH CÔNG MÀ THỂ LỰC VẪN CÒN NGUYÊN 70%



ÙM!
ÙM!

GIẢI THÍCH GÌ MÀ CHẴ HIỂU GÌ HẾT TRON ...

KỂ ĐẾN LÀ TRƯỜNG HỢP CỦA SASUKE KUN

TUY PHÂN THÂN ĐƯỢC 4 NGƯỜI ... NHUNG VÌ KHÔNG THỂ CHUYỂN ĐỔI 40% CHAKRA ĐÓ TRỞ LẠI THÀNH THỂ LỰC NÊN THÀNH RA LÃNG PHÍ MẤT 10% THỂ LỰC ... THỂ LỰC CÒN LẠI CÓ 60%!

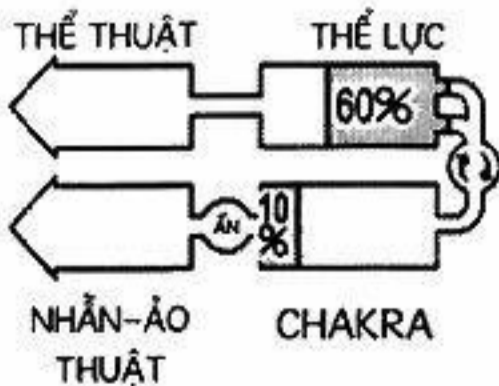
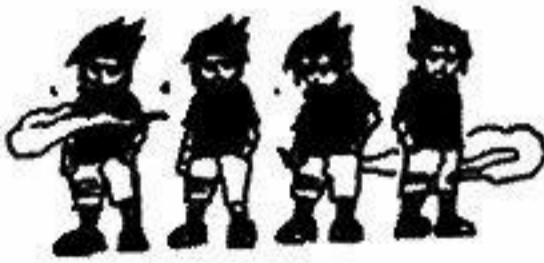

[SỨC CHỊU ĐUNG CÒN LẠI 60% ... HAO PHÍ MẤT 10% CHAKRA]

NHUNG KHI NIỆM ẤN THÌ CÓ THỂ ĐIỀU CHỈNH TỐT NHƯ SAKURA KUN NÊN KHÔNG CÓ VẤN ĐỀ GÌ CẢ ...

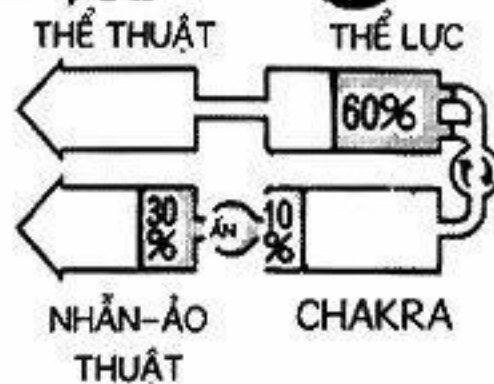

[PHẦN NÀY THÌ TỐT GIỐNG SAKURA KUN]

VÌ NÉN CHAKRA KHÔNG GIỚI NÊN THAY VÌ CHỈ NÉN 30% THÌ EM ẤY LẠI NÉN TỚI 40%

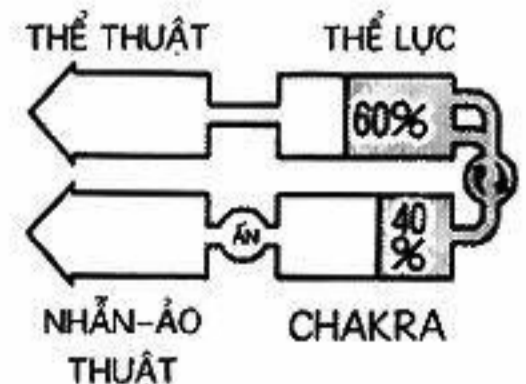

[LỖ NÉN DƯ MẤT 10%]



KẾT CUỘC, THỂ LỰC CHỈ CÒN 50%, HAO PHÍ MẤT 40% CHAKRA NÊN CUỐI CÙNG CHỈ PHÂN THÂN ĐƯỢC CÓ 2! TUY DÙNG CHUNG 1 THUẬT NHUNG CẢ 3 LẠI KHÁC NHAU ĐẾN VẬY ĐẤY!

SAU ĐÓ KHI NIỆM ẮN, VÌ EM ĐIỀU CHỈNH CHAKRA QUÁ TỆ NÊN THAY VÌ PHẢI SỬ DỤNG HẾT 30% THÌ EM LẠI SỬ DỤNG CÓ 10% ...

EM VÌ NÉN CHAKRA CÒN TỆ HƠN C SASUKE KUN NÊN THAY VÌ CHỈ NÉN 30% THÌ EM LẠI NÉN TỚI 50%

THUẬT PHÂN THÂN!

H M M M !!!

THỂ THUẬT THỂ LỰC

NHÃN-ÁO THUẬT CHAKRA

THỂ LỰC CÒN LẠI 50% ...
HAO PHÍ MẤT 40% CHAKRA]

THỂ THUẬT THỂ LỰC

NHÃN-ÁO THUẬT CHAKRA

[LỄ RA PHẢI LÀ 30%]

THỂ THUẬT THỂ LỰC

NHÃN-ÁO THUẬT CHAKRA

[LỖ NÉN DƯ MẤT 20%]



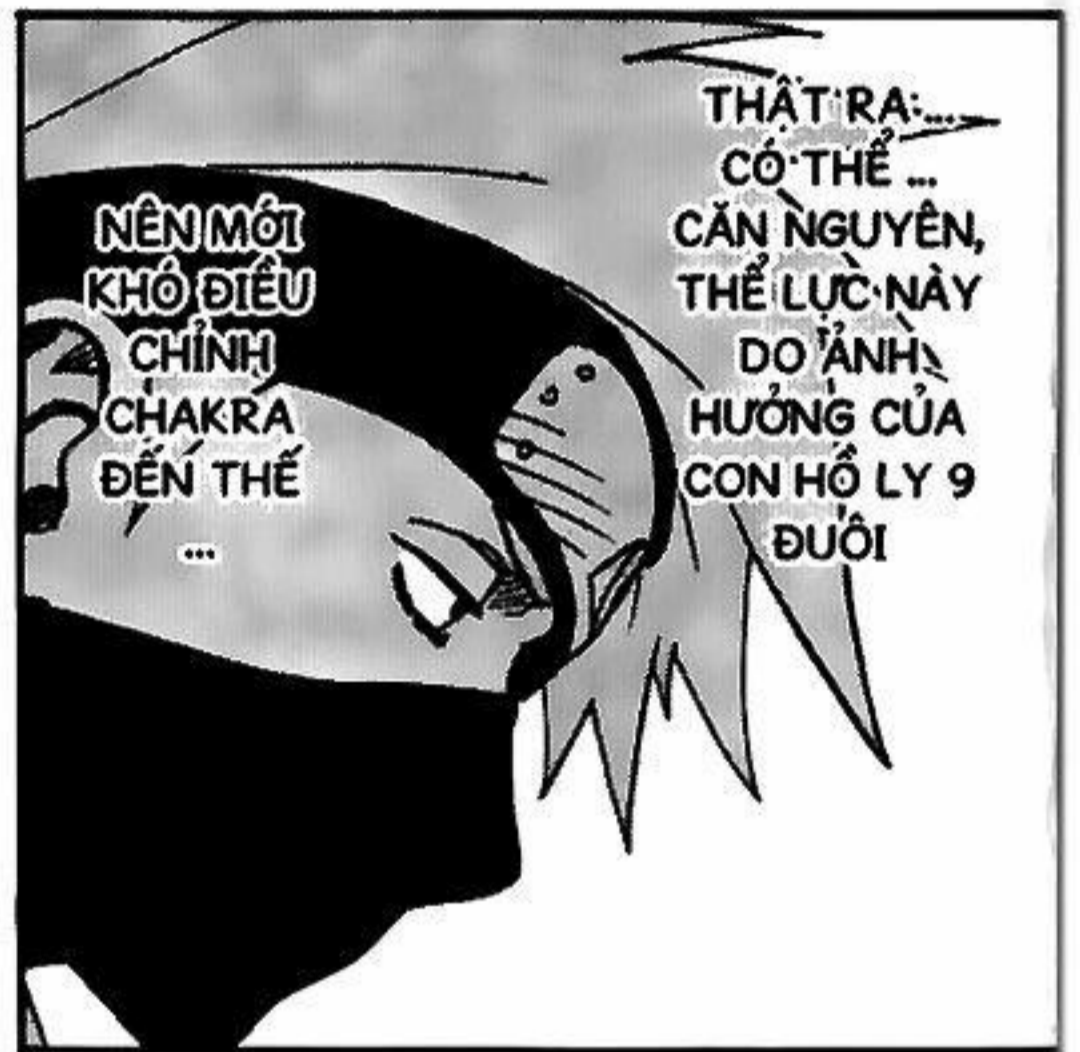





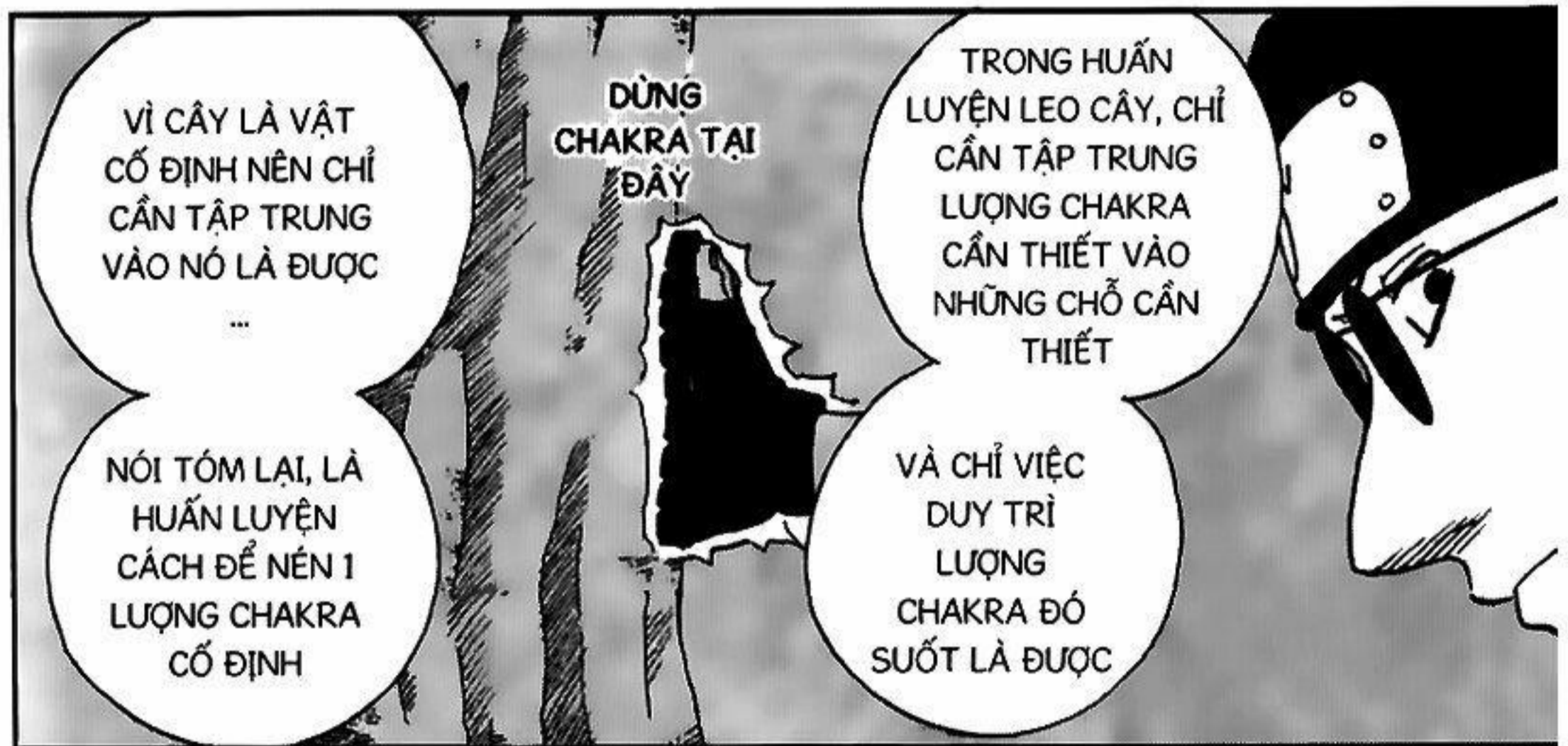

SAO CHO CÂN ĐỐI VỚI TRỌNG LƯỢNG CƠ THỂ ...

SAU ĐÓ, PHÓNG 1 LƯỢNG CHAKRA CỐ ĐỊNH ...

BŨM

ĐÚNG LÀ PHẢI LÀM CHO EM THẤY, EM MỚI HIỂU

HỪ

TRỜI ... CHẢ HIỂU GÌ HẾT !

PHỤC

ĐẦU TIÊN LÀ TẬP TRUNG CHAKRA DƯỚI CHÂN

Ồ
Ồ
!

BŨM BŨM

SAU ĐÓ LÀ PHÓNG 1 LƯỢNG CỐ ĐỊNH CHÚ GÌ !

KỊCH

BŨM

ĐẦU TIÊN LÀ TẬP TRUNG DƯỚI CHÂN !

ĐƯỢC, EM CŨNG PHẢI LÀM THỬ MỚI ĐƯỢC !

TỔM

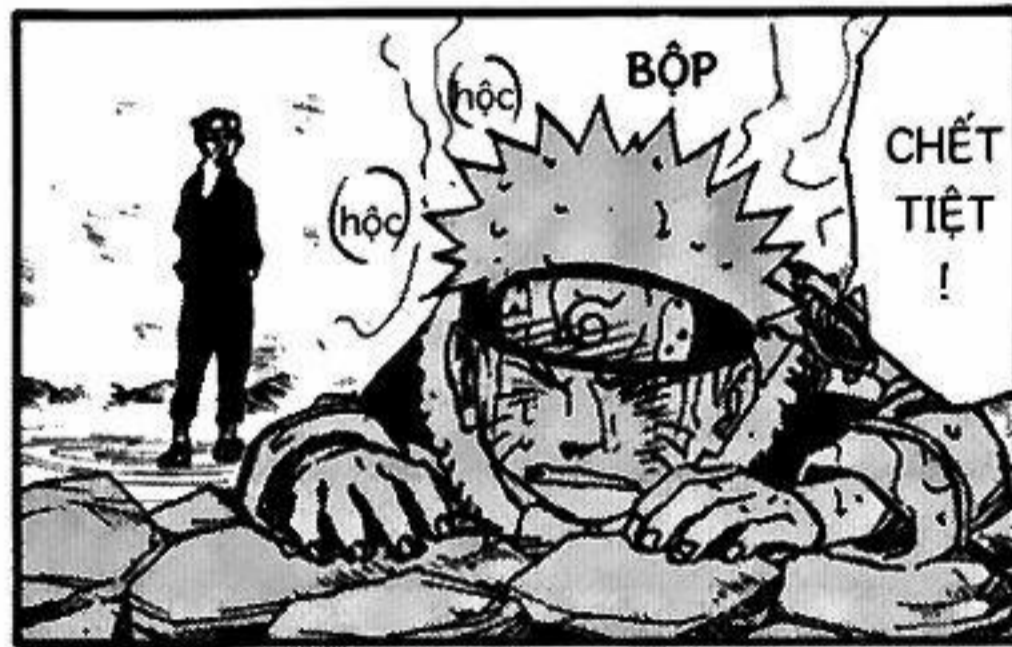





THÌ PHẢI CHUẨN BỊ TINH THẦN TRƯỚC!

NẾU MUỐN TRỞ THÀNH HOKAGE ...

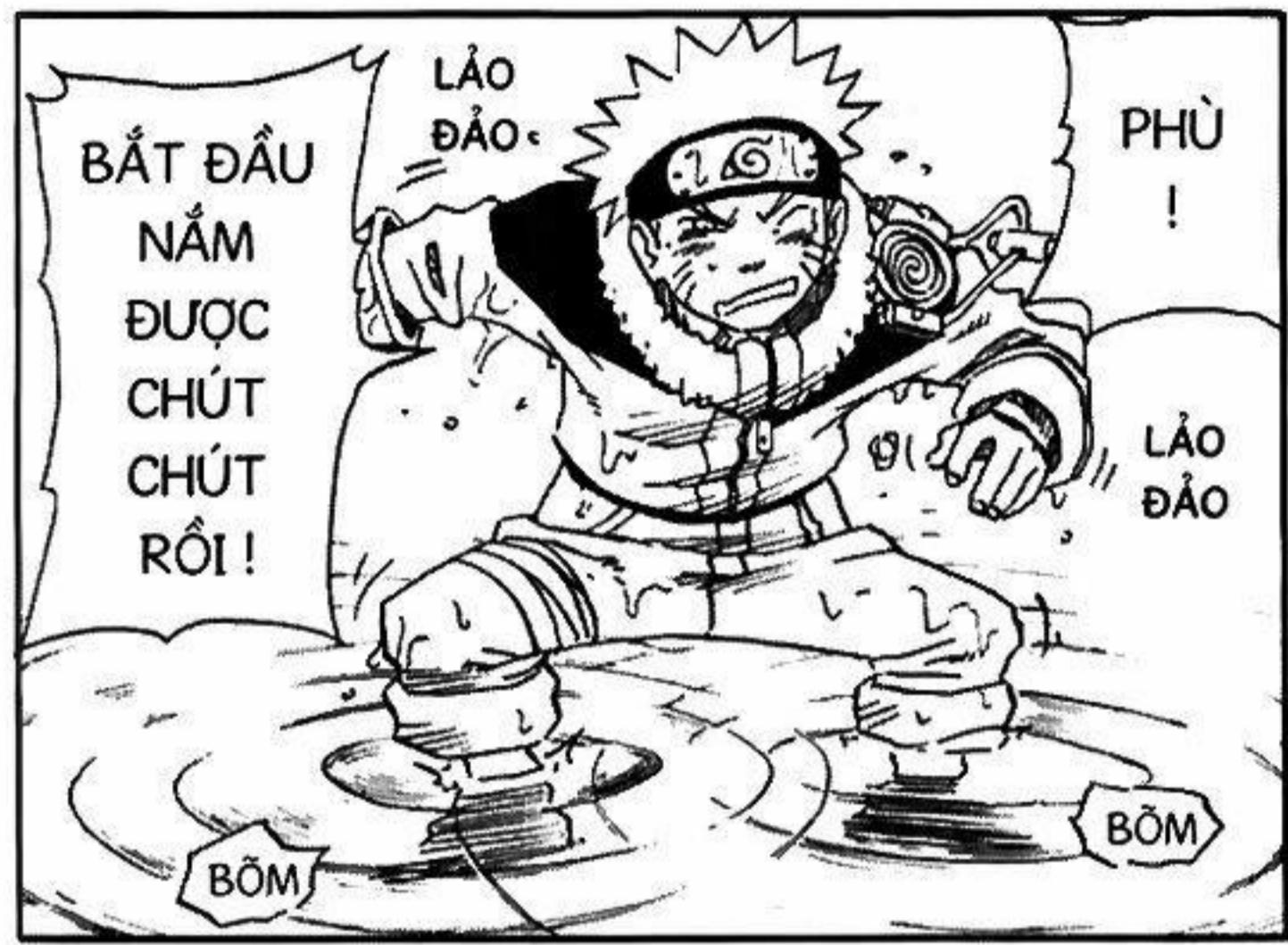

BẮT ĐẦU NẮM ĐƯỢC CHÚT CHÚT RỒI!

LÃO ĐÀO

PHÙ!

LÃO ĐÀO

BỒM

BỒM



EM CÓ LẼ LÀ MỘT GIA SƯ TỐT HƠN TA Đấy ...

TA ĐÃ HIỂU SAI VỀ EM ...

VÀ EM CŨNG KHÔNG PHẢI LÀ CON HỒ LY 9 ĐUÔI TÂM THƯỜNG ...



KHÔNG NGỜ EM LẠI TIẾN BỘ ĐẾN VẬY ...

NẮM ĐƯỢC CÁCH ĐIỀU CHỈNH NÀY NHANH ĐẾN VẬY ...



CÁCH NÀO NGẮN NHẤT CẢ ...

QUẢ THẬT KHÔNG CÓ ...

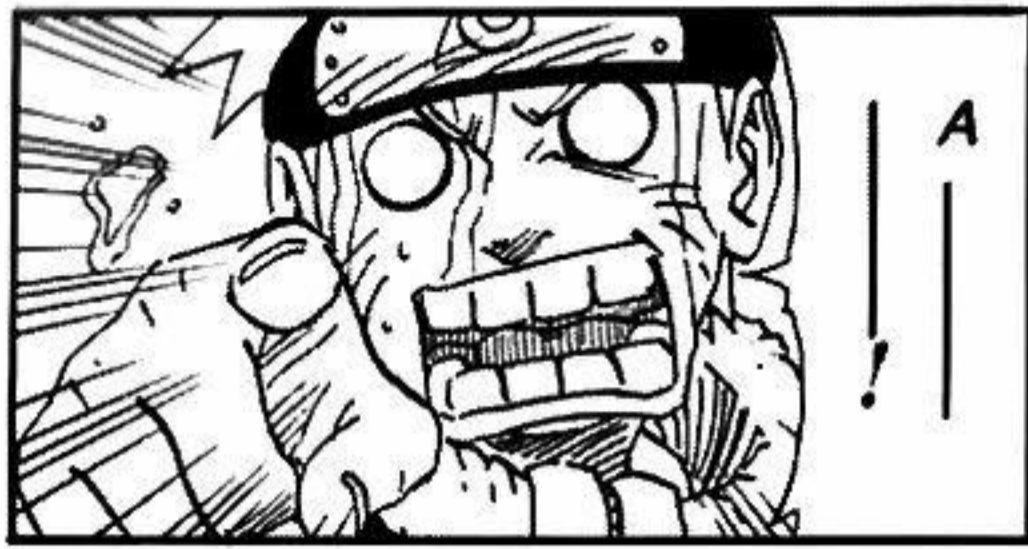

A



MÀ LÀ MỘT NINJA



TUM

OAI



HÊ HÊ HÊ HÊ



HỜ ?

NHUNG TA SẼ KHÔNG THA CHO NHỮNG KẺ DÁM GIỎ TRÒ VÔ LIÊM SỈ NHƯ THẾ !!!

BỘP



KHÔNG CẦN BIẾT NGƯỜI LÀ THẦN THÁNH PHƯƠNG NÀO



HỪ



PÓC

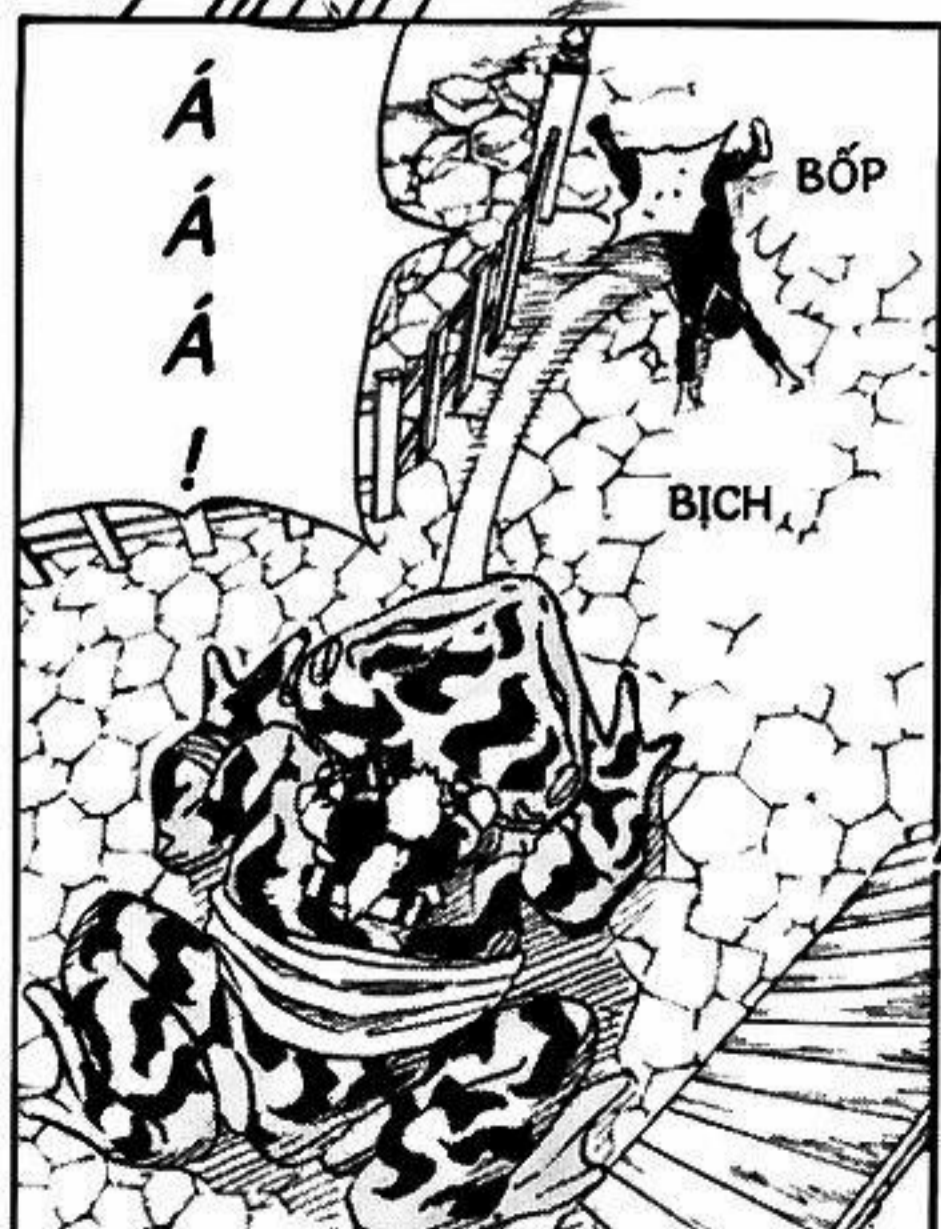

Á Á Á!

BỐP

BỊCH



TH..
THÌ RA
LÀ
!!





LỖ BỊ
PHÁT
HIỆN THÌ
SAO!

THIỆT LÀ ...
LÀM GÌ MÀ
ỒN ÀO VẬY
HẢ



ÔNG GIÀ
DÊ CỤ
NÀY
THẬT RA
LÀ AI !!!

ÔNG THẤY
DÊ XÔM
THUA MẤT
RỒI ?



NARUTO

NGUỒN : BLOGTRUYEN.COM

SCAN : NGANKVN

Edit : [KYO](#)

CÁC NƠI KHÁC VUI LÒNG :

- GHI RÕ NGUỒN : BLOGTRUYEN.COM
- POST SAU BLOGTRUYEN.COM 2 CHAP
- KHÔNG XÓA-SỬA CREDIT VÀ TRANG TRUYỆN

